



Zfx™ Implantatprothetik- Komponenten

Produktkatalog



Get connected!

Noch mehr Freiheit für den Anwender.
Jetzt kostenlos Zfx Bibliotheken downloaden!

exocad

 dental wings

3shape 



DIRECT SERVER
CONNECTION



Zfx

3shape

Software Update

Kompatibel mit der neuesten Zimmer Biomet / Zfx
Implantat-Bibliothek mit Camlog, Dentsply Implants,
Megagen, Nobel Biocare, Straumann, Zimmer Biomet ...

Zfx

Jetzt die gesamten Zfx Restaurativen Bibliotheken
kostenlos herunterladen: www.zfx-dental.com





Inhaltsverzeichnis & Legende

Zimmer Biomet Conical®	12	Megagen AnyOne®	52
Zimmer Biomet Certain®	14	Megagen AnyRidge®	53
Zimmer Biomet External Hex®	16	Megagen EZ Plus®	54
Zimmer Biomet Eztetic Implant®	18	Megagen Multi-Unit Abutment®	56
Zimmer Biomet IOL®	20	Megagen Rescue Internal®	58
Zimmer Biomet Low Profile®	21	Microdent Trylogic®	60
Zimmer Biomet Shoulder Abutment®	22	MIS Internal Hex®	61
Zimmer Biomet SwissPlus®	24	MIS Multi-Unit®	62
Zimmer Biomet Tapered Screw-Vent®	26	Nobel Biocare Active®	64
Zimmer Biomet Tapered Abutment®	28	Nobel Biocare Brånemark®	66
Anthogyr Axiom®	29	Nobel Biocare Multi-unit®	68
Anthogyr Multi Unit®	29	Nobel Biocare Replace®	70
Biotech Dental Conical abutment®	30	Osstem GS & TS System®	72
Biotech Dental Kontakt®	30	P-I Amplified®	74
BioHorizons Internal®	31	P-I Conical Abutment®	75
BioHorizons Multi-Unit®	32	P-I External Hexagon®	76
Bredent SKY uni.cone®/SKY fast and fixed®	33	P-I Morse Taper®	77
Bredent SKY®	34	Serf Multi DIE®	78
Camlog Screw-Line®	36	Serf MUA TR WD®	79
Camlog VARIO SR®	38	Straumann Institut Bone Level®	80
Dentium Superline & Implantium®	39	Straumann Institut Multi-Base®	82
Dentium Screw Abutment®	39	Straumann Institut NNC®	83
Dentsply Implants (Astratech) EV®	40	Straumann Institut Octa® (External Octagon)	84
Dentsply Implants Frialit-Xive®	42	Straumann Institut Screw-retained®	85
Dentsply Implants Multi-Purpose®	44	Straumann Institut SynOcta®	86
Dentsply Implants Osseospeed®	46	Straumann Institut SynOcta® Cementable	88
Dentsply Implants (Astratech) UniAbutment®	48	Sweden & Martina Global®	90
Global D. Angled conical®	50	Sweden & Martina Outlink2®	91
Global D. In-Kone	50	Sweden & Martina Premium Kohno®	92
Global D. Straight conical®	51	Thommen Medical SPI®	94
Global D. Twinkon®	51		

Hinweis

Die Darstellungen der Komponenten können vom Original abweichen. Die Angaben beziehen sich auf die Verwendung der Geometrie selbst und nicht ausschließlich auf der Titanbasis.

Ø Durchmesser

	3,0 – 3,9 mm		5,0 – 5,9 mm
	4,0 – 4,9 mm		6,0 – 6,9 mm

 Drehmoment
für Schrauben



Hersteller/ Implantatsysteme	Desktop Scanbody	IOS Scanbody	Titanbasis mit Rotationschutz	Titanbasis ohne Rotationschutz	Pre-Abutment Blank	Modellanalog
Zimmer Biomet						
Conical®	✓	✓		✓		✓
Certain®	✓	✓	✓	✓	✓	✓
External Hex®	✓	✓	✓	✓	✓	✓
Eztetic Implant®	✓				✓	✓
IOL®	✓	✓		✓		✓
Low Profile®	✓	✓		✓		✓
Shoulder Abutment®	✓	✓		✓		✓
SwissPlus®	✓	✓	✓	✓		✓
Tapered Screw-Vent®	✓	✓	✓	✓	✓	✓
Tapered Abutment®	✓	✓		✓		✓
Anthogyr						
Axiom®	✓					
Multi Unit®	✓					
Biotech Dental						
Conical abutment®	✓					
Kontakt®	✓					
BioHorizons						
Internal®	✓	✓				✓
Multi-Unit®	✓	✓				
Bredent						
SKY uni.cone® / SKY fast and fixed®	✓	✓		✓		✓
SKY®	✓	✓	✓	✓		✓
Camlog						
Screw-Line®	✓	✓		✓		✓
VARIO SR®	✓	✓	✓			✓
Dentium						
Superline & Implantium®	✓					
Screw Abutment®	✓	✓				
Dentsply Implants						
EV®	✓				✓	
Frialit-Xive®	✓	✓	✓	✓	✓	✓
Multi-Purpose®	✓	✓		✓		✓
Ossesospeed®	✓	✓	✓	✓		✓
UniAbutment®	✓	✓		✓		✓
Global D.						
Angled conical®	✓					
In-Kone	✓					
Straight conical®	✓					
Twinkon®	✓					

Für alle aufgeführten Systeme sind Bibliotheken für RealCAD, Exocad, 3Shape und DentalWings erhältlich.



Hersteller/ Implantatsysteme	Desktop Scanbody	IOS Scanbody	Titanbasis mit Rotationschutz	Titanbasis ohne Rotationschutz	Pre-Abutment Blank	Modellanalog
Megagen						
AnyOne®	✓	✓				
AnyRidge®	✓	✓	✓			✓
EZ Plus®	✓	✓	✓	✓		✓
Multi-Unit Abutment®	✓	✓				
Rescue Internal®	✓	✓	✓	✓		✓
Microdent						
Trylogic®	✓	✓				
MIS						
Internal Hex®	✓	✓				✓
Multi-Unit®	✓					
Nobel Biocare						
Active®	✓	✓	✓	✓	✓	✓
Bränemark®	✓	✓	✓	✓	✓	✓
Multi-unit®	✓	✓		✓		✓
Replace®	✓	✓	✓	✓	✓	✓
Osstem						
GS & TS System®	✓	✓	✓	✓		✓
P-I						
Amplified®	✓	✓				✓
Conical Abutment®	✓	✓				
External Hexagon®	✓	✓				✓
Morse Taper®	✓	✓				✓
Serf						
Multi DIE®	✓					
MUATR WD®	✓					
Straumann Institut						
Bone Level®	✓	✓	✓	✓	✓	✓
Multi-Base®	✓	✓		✓		✓
Narrow Neck®	✓					
Octa® (External Octagon)	✓					
Screw-retained®	✓	✓				
SynOcta®	✓	✓	✓	✓	✓	✓
SynOcta® Cementable	✓	✓				✓
Sweden & Martina						
Global®	✓	✓				✓
Outlink 2®	✓	✓				✓
Premium Kohno®	✓	✓				✓
Thommen Medical						
SPI®	✓	✓				✓

Die Werte können abweichen. Aktuelle Angaben finden Sie in den Sicherheitsdatenblättern unter www.zfx-dental.com



Zfx Ti-Basen

Die Zfx Ti-Basen gibt es in verschiedenen Ausführungen und sorgen für eine stets optimale Implantat-Abutment-Verbindung. Titanbasen mit Rotationsschutz werden für Einzelversorgungen empfohlen. Titanbasen ohne Rotationsschutz werden bevorzugt, wenn Restaurationen mit mehreren Einheiten geplant werden. Zfx Ti-Basen werden mit Titanschrauben geliefert.

Offenes System mit unbegrenzten Möglichkeiten

Für die digitale Herstellung von Zahnersatz setzt Zfx auf offene Konnektivität. Jeder Schritt des Arbeitsablaufs, vom Scannen bis zur Produktion, ermöglicht die Integration von Drittanbietern oder Partner-Systemen. 3Shape, Exocad und Dental Wings Nutzer können die Zfx Bibliothek herunterladen und alle Implantatprothetik-Komponenten kostenlos nutzen.

3shape 

exocad

 dental wings



GRATIS!

Zfx Restaurative
Bibliotheken Download

www.zfx-dental.com



GRATIS DOWNLOAD

Jetzt die Zfx Restaurative Bibliotheken kostenlos
herunterladen: www.zfx-dental.com



Regular & Small Design

Erstellung des idealen Emergenzprofiles

Zahnimplantate sind zu einer gängigen restaurativen Option geworden deren Verwendung die Wissenschaft der restaurativen Zahnheilkunde revolutioniert hat. Das ultimative Ziel einer Implantatversorgung ist sowohl die Funktionalität als auch die Ästhetik.

Das Emergenzprofil spielt bei der Erstellung einer gesund und natürlich aussehenden implantatgetragenen Krone eine entscheidende Rolle. Die endgültige Position und Form des Zahnfleischrandes und der Druck, der auf das Gewebe ausgeübt wird, kann durch die Veränderung der Kontur des Emergenzprofiles beeinflusst werden.

Eine optimale Ästhetik kann erreicht werden, indem das Emergenzprofil verwendet wird, um die Höhe und Form der peri-koronaren Weichteile wiederherzustellen. Durch die Bereitstellung eines stabilen und gesunden Verhältnisses zwischen Abutment und Gewebe kann ein langfristiger Erfolg erzielt werden.

„Small Series“ Titan-Implantat-Schnittstelle

Zfx bietet mit der „Small Serie“ ein Titan-Interface, das es ermöglicht, mit reduziertem Durchmesser des

Implantatniveaus ein individuelleres Emergenzprofil zu gestalten. Die Höhe der Plattform, auf der die endgültige Restauration zementiert wird, wurde ebenfalls gesenkt, wodurch ein dünnerer Metallrand an der Basis des Abutments entsteht. Dies hat die durch das Weichgewebe hervorgerufene Schattenbildung deutlich reduziert, wodurch ein ästhetisch überlegenes Abutment geschaffen werden kann.

Diese Schnittstellen der „Small Serie“ eignen sich für alle Indikationen und bieten die dringend benötigte Vielseitigkeit im Gesamtdesign einer Implantat-Abutment-Restauration. Sie sind besonders nützlich in Fällen mit dünnen Weichteilbiotypen, engen, faserigen Gewebeprofilen oder flachen Implantatplatzierungen, in denen es traditionell schwierig war, ideale Ergebnisse zu erzielen.

Die Titan-Schnittstellen der „Regular Serie“ sind weiterhin verfügbar. Sie werden für dickere Weichteilbiotypen verwendet, bei denen ein erhöhter Weichgewebedruck durch ein aufgeweitetes Emergenzprofil benötigt wird, um das umgebende Weichgewebe zu formen und zu konturieren.

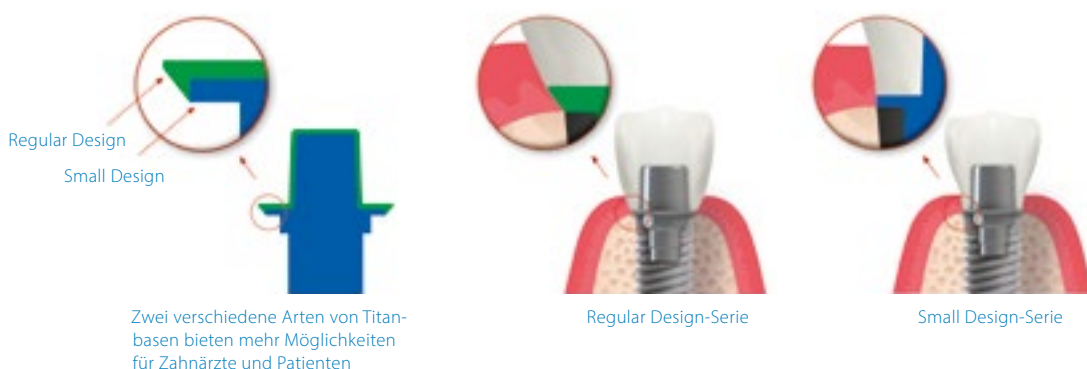

Zwei verschiedene Arten von Titanbasen bieten mehr Möglichkeiten für Zahnärzte und Patienten

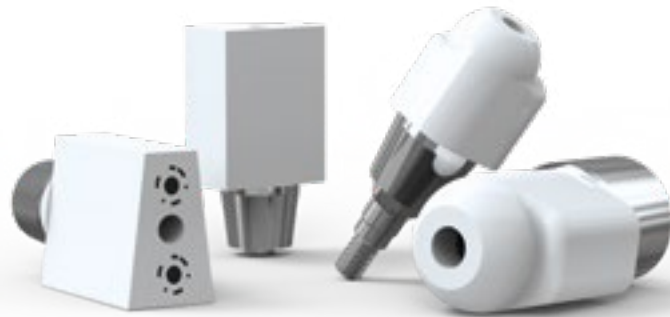

Zfx Scanbodies

Zfx Desktop Scanbody

Der Scan ist die Grundlage jeder digital gefertigten Restauration. Scanbodies versprechen eine maximale Scangenauigkeit. Die zweiteiligen Desktop-Scanbodies zur Mehrfachnutzung werden mit einem innovativen Codesystem versehen, das die automatische Erkennung des Implantattyps ermöglicht und Anwendungsfehler verhindert. Aufgrund seiner hohen Genauigkeit, die durch das Material PEEK ermöglicht wird, eignet sich der Scanbody auch zum Scannen von Implantatbrücken. Alle Zfx Desktop Scanbodies haben eine integrierte Schraube, für die ein dafür konstruierter Drehmomentschlüssel verwendet werden muss. Für die integrierten Schrauben kann nicht der Originalschlüssel des Implantatsystems verwendet werden. Desktop Scanbodies sind in verschiedenen Durchmessern erhältlich. Zahnärzte und Labore, die mit dem automatisierten Zfx Evolution Workflow arbeiten, müssen berücksichtigen, dass für jedes Implantatsystem alle Durchmesser benötigt werden.

Drehmomentschlüssel für Zfx Desktop Scanbodies

Der Drehmomentschlüssel wird zum Festziehen der Zfx Desktop Scanbodies benötigt. Außerdem dient er als Universalschlüssel (1,25 mm HEX) und hat eine Rutschkupplung, die ein gleiches Anzugsdrehmoment für jeden Matchholder garantiert.

Art.-Nr. ZFX02002067



Drehmomentschlüssel für Zfx Desktop Scanbodies, Art.-Nr. ZFX02002067

Zfx IOS Scanbody

Die IOS Scanbodies sind in 2 verschiedenen Höhen erhältlich (H4 – 4 mm oder H7 – 7 mm) – zur Anpassung an Tiefe und Gingivahöhe des Patienten. Der Scanbody H7 hat eine zusätzliche Stufe, um beim Designen in der CAD-Software eine Verwechslung der beiden Höhen vermeiden zu können. In allen Zfx IOS Scanbodies ist eine Schraube mit einem 1,25 mm HEX integriert.

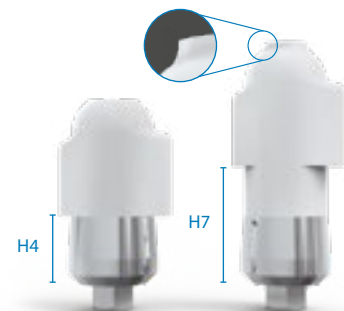

Schraubendreher-Einsätze für Zfx Desktop Scanbodies und Zfx IOS Scanbodies

Der Sechskant-Schraubendreher in der Ausführung **FUJI** ist kompatibel mit allen Zfx Scanbodies. Die drei unterschiedlichen Längen, erlauben eine bestmögliche Anwendung zum Fixieren der Scanbodies am Patienten oder Labor. Weiter Informationen finden Sie auf Seite 9.

FUJI (L 21 mm) Art. Nr. ZFX02HD12721

FUJI (L 28 mm) Art. Nr. ZFX02HD12728

FUJI (L 36 mm) Art. Nr. ZFX02HD12736



Zfx Modellanaloge

Die Modellanaloge werden für Modelle verwendet, die mithilfe des Zfx Digital intraModel Systemes erstellt wurden. Seitlich eingesetzte Aretierstifte gewährleisten die exakte Position des Modellanalogs im Modell. Die Modellanaloge können auch, wie üblich, in einem Gipsmodell mithilfe eines Abdruck implementiert werden.



Das Zfx Digital-intraModel System ermöglicht eine computerunterstützte Produktion physikalischer Modelle basierend auf intraoralen Scans.



Zfx Pre-milled Abutment Blanks

Die Zfx Pre-milled Abutment Blanks bieten die Möglichkeit, einteilige, individuelle Titan Abutments zeit- und kostengünstig im eigenen Labor zu fertigen.

Diese sind kompatibel zu zahlreichen CAM Systemen (exocad, dental wings, 3shape, ...) und können mit allen offenen CAM Maschinen verarbeitet werden (Zfx, imes-icore, Sirona, vhf, Datron und viele mehr).



Der Zfx Pre-milled Abutment Multi-Blank Halter ermöglicht die Bestückung und Verwaltung von bis zu 12 Blöcke.

Die Zfx Pre-milled Abutment Blanks sind kompatibel mit Medentika PreFace® Abutment Haltern. (CAM Update erforderlich!)

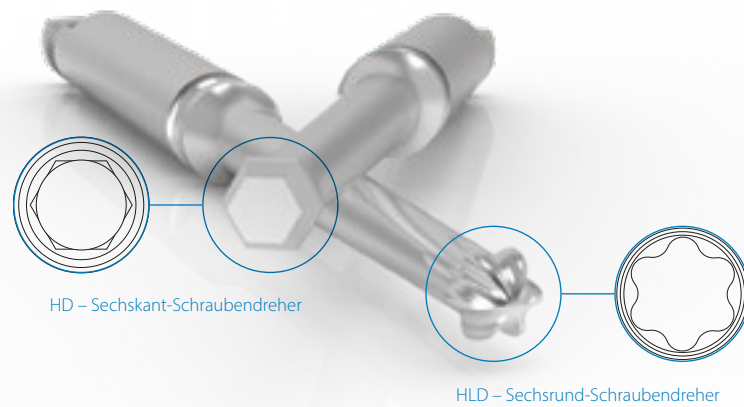

Zfx Schraubendreher-Einsätze

Die Zfx Hex/Hexalobular Schraubendreher-Einsätze haben einen ISO-Latch Schaft nach ISO-1797 Standard. Die Anwendung der Schraubendreher ist für den Gebrauch in Laboren und in Zahnarztpraxen am Patienten validiert. Die Einsätze können direkt in Handstücke/Winkelstücke oder mithilfe von Adaptern, die das Einspannen von Schäften nach ISO-1797 erlauben, eingespannt werden.

Die Schraubendreher sind in drei verschiedenen Längen (21, 28 und 36 mm) erhältlich. Die zum jeweiligen System passenden Schraubenzieher sind auf den folgenden Seiten bei den Komponenten aufgelistet.

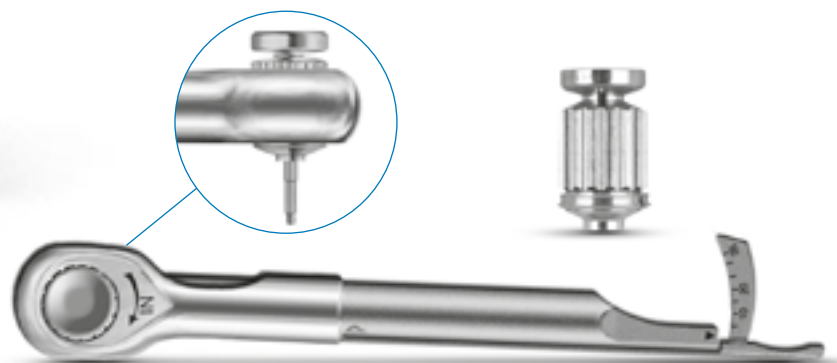
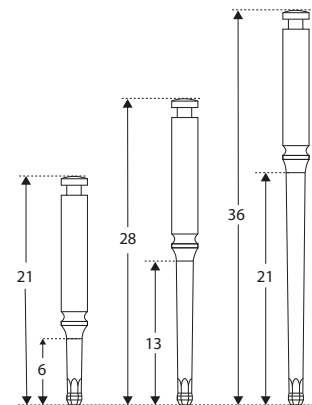

Die Zfx Hex/Hexalobular Schraubendreher-Einsätze haben einen ISO-Latch Schaft nach ISO-1797 Standard und sind mit entsprechenden Winkelstücken kompatibel.

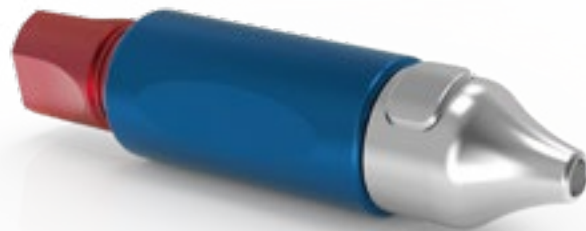



Zfx Torque Handstück für ISO-Latch Schäfte

Das Zfx Torque Handstück ist für Schäfte nach ISO-1797 konzipiert. Somit können alle Zfx Hex/Hexalobular Schraubendreher-Einsätze platziert werden. Das Handstück ist mit einem drei-stufig einstellbaren Drehmoment von ca. 2,7 – 10 Ncm ausgestattet und damit ideal für die unterschiedlichsten Anforderungen im Labor geeignet. Ein Druckkopf, ermöglicht ein einfaches, schnelles Wechseln der Schraubendreher-Einsätze.

Zfx Torque Handstück für ISO-Latch Schäfte
Art.-Nr. ZFX02-TH



Art.-Nr. ZFX02-TH

Übersicht aller Zfx Hex / Hexalobular Schraubendreher-Einsätze

Produkt	Größe	max. Angulation	Max. Drehmoment (Ncm)	Länge (mm)		
				21	28	36
Zfx Hex Screwdriver EVEREST	HD 1,00	20°	15	ZFX02HD10028		
Zfx Hex Screwdriver AORAKI	HD 1,20	20°	35	ZFX02HD12021	ZFX02HD12028	ZFX02HD12036
Zfx Hex Screwdriver FUJI	HD 1,27	20°	40	ZFX02HD12721	ZFX02HD12728	ZFX02HD12736
Zfx Hex Screwdriver BADILE	HD 1,30	20°	40	ZFX02HD13321	ZFX02HD13328	ZFX02HD13336
Zfx Hex Screwdriver DENALI	HD 1,40	20°	40	ZFX02HD14021	ZFX02HD14028	ZFX02HD14036
Zfx Hex Screwdriver PISCO	HD 1,50	20°	40	ZFX02HD15021	ZFX02HD15028	ZFX02HD15036
Zfx Hex Screwdriver VINSON	HD 1,60	20°	40	ZFX02HD16021	ZFX02HD16028	ZFX02HD16036
Zfx Hexalobular Screwdriver EIGER	 HLD 1,54	25°	40	ZFX02HLD15421	ZFX02HLD15428	ZFX02HLD15436
Zfx Hexalobular Screwdriver JORASSES	 HLD 1,68	25°	40	ZFX02HLD16821	ZFX02HLD16828	ZFX02HLD16836
Zfx Hexalobular Screwdriver MERU	 HLD 1,80	25°	40	ZFX02HLD18021	ZFX02HLD18028	ZFX02HLD18036

3i-CO Type für das Zimmer Biomet Conical® Abutmentsystem

Scan-Bodies

	Desktop Scanbody <i>inkl. Standard-Schraube</i>	IOS Scanbody H4 <i>inkl. Standard-Schraube</i>	IOS Scanbody H7
	 IM DOPPELPACK	 IM DOPPELPACK	IM DOPPELPACK
ø3,4mm	EVO-3i-CO-MACH-3.4	INTRA-3i-CO-MACH-3.4-H4	–
Art-Nr.:	ZFX05002158	ZFX05001925	–
ø4,1mm	EVO-3i-CO-MACH-4.1-5.0	INTRA-3i-CO-MACH-4.1-5.0-H4	–
Art-Nr.:	ZFX05002159	ZFX05001926	–
ø5,0mm	EVO-3i-CO-MACH-4.1-5.0	INTRA-3i-CO-MACH-4.1-5.0-H4	–
Art-Nr.:	ZFX05002159	ZFX05001926	–



Einzelkronen-Versorgung

Brücken-Versorgung



	Titanbasis rotationsgeschützt für Einzelkronen		Titanbasis nicht rotationsgeschützt für Brücken <i>Small Design, inkl. Standard-Schraube</i>
			
ø3,4mm	–	–	S-TI-Base-3i-CO-TBUL-3.4
Art-Nr.:	–	–	ZFX11002086
ø4,1mm	–	–	S-TI-Base-3i-CO-TBUL-4.1-5.0
Art-Nr.:	–	–	ZFX11002087
ø5,0mm	–	–	S-TI-Base-3i-CO-TBUL-4.1-5.0
Art-Nr.:	–	–	ZFX11002087

*max. möglicher Schraubenkanal-Winkel

Komponenten-Zubehör

Pre-Abutment Blank		Ersatzschraube <i>Standard-Schraube</i>		Modellanalog	
					IM DOPPELPACK
					
			\vec{M} Drehmoment		
ø3,4 mm	–	3I-CO-SCTI-3.4-6.0	10 Ncm	MC-Analog-3I-CO-3.4	
Art-Nr.:	–	ZFX09001007		ZFX15002289	
ø4,1 mm	–	3I-CO-SCTI-3.4-6.0	10 Ncm	MC-Analog-3I-CO-4.1-5.0	
Art-Nr.:	–	ZFX09001007		ZFX15002290	
ø5,0 mm	–	3I-CO-SCTI-3.4-6.0	10 Ncm	MC-Analog-3I-CO-4.1-5.0	
Art-Nr.:	–	ZFX09001007		ZFX15002290	

Komponenten-Zubehör für direkt-verschraubte Prothetik

Standard-Schraube			Sechsrund-Schraube		
		$\leq 20^\circ^*$			$\leq 25^\circ^*$
					
			\vec{M} Drehmoment		\vec{M} Drehmoment
ø3,4 mm	3I-CO-SCTI-3.4-6.0	10 Ncm	Zfx Hexalobular Screw 3I-CO, 3I-IO	10 Ncm	
Art-Nr.:	ZFX09001007		ZFX09-3I-CO-HL		
ø4,1 mm	3I-CO-SCTI-3.4-6.0	10 Ncm	Zfx Hexalobular Screw 3I-CO, 3I-IO	10 Ncm	
Art-Nr.:	ZFX09001007		ZFX09-3I-CO-HL		
ø5,0 mm	3I-CO-SCTI-3.4-6.0	10 Ncm	Zfx Hexalobular Screw 3I-CO, 3I-IO	10 Ncm	
Art-Nr.:	ZFX09001007		ZFX09-3I-CO-HL		



Schraubendreher

	Standard-Schraube	Sechsrund-Schraube		Scanbodies
ø3,4 mm	AORAKI	MERU		FUJI
ø4,1 mm	AORAKI	MERU		FUJI
ø5,0 mm	AORAKI	MERU		FUJI

 Bestellinformationen zu Schraubendrehern ab Seite 8





3i-CE Type für das Zimmer Biomet Certain® Implantatsystem

Scan-Bodies

		Desktop Scanbody <i>inkl. Standard-Schraube</i>	IOS Scanbody H4 <i>inkl. Standard-Schraube</i>	IOS Scanbody H7 <i>inkl. Standard-Schraube</i>
				
		IM DOPPELPAK	IM DOPPELPAK	IM DOPPELPAK
ø 3,4 mm		EVO-3I-CE-MACH-3.4	INTRA-3I-CE-MACH-3.4-H4	INTRA-3I-CE-MACH-3.4-H7
Art-Nr.:		ZFX05002018	ZFX05001942	ZFX05001943
ø 4,1 mm		EVO-3I-CE-MACH-4.1	INTRA-3I-CE-MACH-4.1-H4	INTRA-3I-CE-MACH-4.1-H7
Art-Nr.:		ZFX05002019	ZFX05001944	ZFX05001945
ø 5,0 mm		EVO-3I-CE-MACH-5.0	INTRA-3I-CE-MACH-5.0-H4	INTRA-3I-CE-MACH-5.0-H7
Art-Nr.:		ZFX05002020	ZFX05001946	ZFX05001947
ø 6,0 mm		EVO-3I-CE-MACH-6.0	INTRA-3I-CE-MACH-6.0-H4	INTRA-3I-CE-MACH-6.0-H7
Art-Nr.:		ZFX05002021	ZFX05001948	ZFX05001949

Einzelkronen-Versorgung

Brücken-Versorgung

		Titanbasis rotationsgeschützt für Einzelkronen <i>Regular Design, inkl. Standard-Schraube Small Design, inkl. Standard-Schraube</i>		Titanbasis nicht rotationsgeschützt für Brücken <i>Regular Design, inkl. Standard-Schraube Small Design, inkl. Standard-Schraube</i>	
					
ø 3,4 mm		TI-Base-3I-CE-TBLO-3.4	S-TI-Base-3I-CE-TBLO-3.4	TI-Base-3I-CE-TBUL-3.4	S-TI-Base-3I-CE-TBUL-3.4
Art-Nr.:		ZFX11000668	ZFX11001096	ZFX11000672	ZFX11001100
ø 4,1 mm		TI-Base-3I-CE-TBLO-4.1	S-TI-Base-3I-CE-TBLO-4.1	TI-Base-3I-CE-TBUL-4.1	S-TI-Base-3I-CE-TBUL-4.1
Art-Nr.:		ZFX11000669	ZFX11001097	ZFX11000673	ZFX11001101
ø 5,0 mm		TI-Base-3I-CE-TBLO-5.0	S-TI-Base-3I-CE-TBLO-5.0	TI-Base-3I-CE-TBUL-5.0	S-TI-Base-3I-CE-TBUL-5.0
Art-Nr.:		ZFX11000670	ZFX11001098	ZFX11000674	ZFX11001102
ø 6,0 mm		–	S-TI-Base-3I-CE-TBLO-6.0	–	S-TI-Base-3I-CE-TBUL-6.0
Art-Nr.:		–	ZFX11000671	–	ZFX11000675

*max. möglicher Schraubenkanal-Winkel

Komponenten-Zubehör

Pre-Abutment Blank
inkl. Standard-Schraube**Ersatzschraube**
Standard-Schraube**Modellanalog**

IM DOPPELPAK



ø3,4 mm	Pre-Abutment Blank	3i-CE-SCTI-3.4-6.0	20 Ncm	MC-Analog-3i-CE-3.4
Art-Nr.:	ZFX18000350	ZFX09000978		ZFX15002116
ø4,1 mm	Pre-Abutment Blank	3i-CE-SCTI-3.4-6.0	20 Ncm	MC-Analog-3i-CE-4.1
Art-Nr.:	ZFX18000360	ZFX09000978		ZFX15002117
ø5,0 mm	Pre-Abutment Blank	3i-CE-SCTI-3.4-6.0	20 Ncm	MC-Analog-3i-CE-5.0
Art-Nr.:	ZFX18000360	ZFX09000978		ZFX15002118
ø6,0 mm	Pre-Abutment Blank	3i-CE-SCTI-3.4-6.0	20 Ncm	MC-Analog-3i-CE-6.0
Art-Nr.:	ZFX18000360	ZFX09000978		ZFX15002119

Komponenten-Zubehör für direkt-verschraubte Prothetik

Standard-Schraube**Standard-Brückenschraube****Sechsrund-Schraube****Sechsrund-Brückenschraube**

≤ 20°*

≤ 20°*

≤ 25°*

≤ 25°*



ø3,4 mm	3i-CE-SCTI-3.4-6.0	20 Ncm	3i-CE-SCTIUN-3.4-6.0	20 Ncm	HL Screw 3i-CE	20 Ncm	3i-CE	20 Ncm
Art-Nr.:	ZFX09000978		ZFX09002410		ZFX09-3i-CE-HLE		ZFX09-3i-CE-HLN	
ø4,1 mm	3i-CE-SCTI-3.4-6.0	20 Ncm	3i-CE-SCTIUN-3.4-6.0	20 Ncm	HL Screw 3i-CE	20 Ncm	3i-CE	20 Ncm
Art-Nr.:	ZFX09000978		ZFX09002410		ZFX09-3i-CE-HLE		ZFX09-3i-CE-HLN	
ø5,0 mm	3i-CE-SCTI-3.4-6.0	20 Ncm	3i-CE-SCTIUN-3.4-6.0	20 Ncm	HL Screw 3i-CE	20 Ncm	3i-CE	20 Ncm
Art-Nr.:	ZFX09000978		ZFX09002410		ZFX09-3i-CE-HLE		ZFX09-3i-CE-HLN	
ø6,0 mm	3i-CE-SCTI-3.4-6.0	20 Ncm	3i-CE-SCTIUN-3.4-6.0	20 Ncm	HL Screw 3i-CE	20 Ncm	3i-CE	20 Ncm
Art-Nr.:	ZFX09000978		ZFX09002410		ZFX09-3i-CE-HLE		ZFX09-3i-CE-HLN	

Schraubendreher



Standard-Schraube**Sechsrund-Schraube****Scanbodies**

ø3,4 mm	AORAKI	MERU	FUJI
ø4,1 mm	AORAKI	MERU	FUJI
ø5,0 mm	AORAKI	MERU	FUJI
ø6,0 mm	AORAKI	MERU	FUJI

Bestellinformationen zu Schraubendrehern ab Seite 8





3i-OS Type für das Zimmer Biomet External Hex® Implantatsystem

Scan-Bodies

		Desktop Scanbody <i>inkl. Standard-Schraube</i>	IOS Scanbody H4 <i>inkl. Standard-Schraube</i>	IOS Scanbody H7 <i>inkl. Standard-Schraube</i>
				
		IM DOPPELPAK	IM DOPPELPAK	IM DOPPELPAK
ø 3,4 mm	EVO-3I-OS-MACH-3.4	INTRA-3I-OS-MACH-3.4-H4	INTRA-3I-OS-MACH-3.4-H7	
Art-Nr.:	ZFX05002022	ZFX05001950	ZFX05001951	
ø 4,1 mm	EVO-3I-OS-MACH-4.1	INTRA-3I-OS-MACH-4.1-H4	INTRA-3I-OS-MACH-4.1-H7	
Art-Nr.:	ZFX05002023	ZFX05001952	ZFX05001953	
ø 5,0 mm	EVO-3I-OS-MACH-5.0	INTRA-3I-OS-MACH-5.0-H4	INTRA-3I-OS-MACH-5.0-H7	
Art-Nr.:	ZFX05002024	ZFX05001954	ZFX05001955	
ø 6,0 mm	EVO-3I-OS-MACH-6.0	INTRA-3I-OS-MACH-6.0-H4	INTRA-3I-OS-MACH-6.0-H7	
Art-Nr.:	ZFX05002025	ZFX05001956	ZFX05001957	

Einzelkronen-Versorgung

Brücken-Versorgung

		Titanbasis rotationsgeschützt für Einzelkronen <i>Regular Design, inkl. Standard-Schraube Small Design, inkl. Standard-Schraube</i>		Titanbasis nicht rotationsgeschützt für Brücken <i>Regular Design, inkl. Standard-Schraube Small Design, inkl. Standard-Schraube</i>	
					
ø 3,4 mm	TI-Base-3I-OS-TBLO-3.4	S-TI-Base-3I-OS-TBLO-3.4	–	S-TI-Base-3I-OS-TBUL-3.4	
Art-Nr.:	ZFX11000676	ZFX11001104	–	ZFX11000680	
ø 4,1 mm	TI-Base-3I-OS-TBLO-4.1	S-TI-Base-3I-OS-TBLO-4.1	–	S-TI-Base-3I-OS-TBUL-4.1	
Art-Nr.:	ZFX11000677	ZFX11001105	–	ZFX11000681	
ø 5,0 mm	TI-Base-3I-OS-TBLO-5.0	S-TI-Base-3I-OS-TBLO-5.0	–	S-TI-Base-3I-OS-TBUL--5.0	
Art-Nr.:	ZFX11000678	ZFX11001106	–	ZFX11000682	
ø 6,0 mm	–	S-TI-Base-3I-OS-TBLO-6.0	–	S-TI-Base-3I-OS-TBUL-6.0	
Art-Nr.:	–	ZFX11000679	–	ZFX11000683	

*max. möglicher Schraubenkanal-Winkel

Komponenten-Zubehör

Pre-Abutment Blank
inkl. Standard-Schraube**Ersatzschraube**
Standard-Schraube
 \vec{M}
Drehmoment
Modellanalog

IM DOPPELPACK

ø3,4 mm	Pre-Abutment Blank	3i-OS-SCTI-3.4-6.0	20 Ncm	MC-Analog-3i-OS-3.4
Art-Nr.:	ZFX18000370	ZFX09000979		ZFX15002120
ø4,1 mm	Pre-Abutment Blank	3i-OS-SCTI-3.4-6.0	20 Ncm	MC-Analog-3i-OS-4.1
Art-Nr.:	ZFX18000380	ZFX09000979		ZFX15002121
ø5,0 mm	Pre-Abutment Blank	3i-OS-SCTI-3.4-6.0	20 Ncm	MC-Analog-3i-OS-5.0
Art-Nr.:	ZFX18000380	ZFX09000979		ZFX15002122
ø6,0 mm	Pre-Abutment Blank	3i-OS-SCTI-3.4-6.0	20 Ncm	MC-Analog-3i-OS-6.0
Art-Nr.:	ZFX18000380	ZFX09000979		ZFX15002123

Komponenten-Zubehör für direkt-verschraubte Prothetik

Standard-Schraube

≤ 20°*

 \vec{M}
Drehmoment
Sechsrund-Schraube

≤ 25°*

 \vec{M}
Drehmoment

ø3,4 mm	3i-OS-SCTI-3.4-6.0	20 Ncm	Zfx Hexalobular Screw 3i-OS	20 Ncm
Art-Nr.:	ZFX09000979		ZFX09-3i-OS-HL	
ø4,1 mm	3i-OS-SCTI-3.4-6.0	20 Ncm	Zfx Hexalobular Screw 3i-OS	20 Ncm
Art-Nr.:	ZFX09000979		ZFX09-3i-OS-HL	
ø5,0 mm	3i-OS-SCTI-3.4-6.0	20 Ncm	Zfx Hexalobular Screw 3i-OS	20 Ncm
Art-Nr.:	ZFX09000979		ZFX09-3i-OS-HL	
ø6,0 mm	3i-OS-SCTI-3.4-6.0	20 Ncm	Zfx Hexalobular Screw 3i-OS	20 Ncm
Art-Nr.:	ZFX09000979		ZFX09-3i-OS-HL	

Schraubendreher

Standard-Schraube**Sechsrund-Schraube****Scanbodies**

ø3,4 mm	AORAKI	MERU	FUJI
ø4,1 mm	AORAKI	MERU	FUJI
ø5,0 mm	AORAKI	MERU	FUJI
ø6,0 mm	AORAKI	MERU	FUJI



Bestellinformationen zu Schraubendrehern ab Seite 8

ZI-EZ Type für das Zimmer Biomet Eztetic Implant® Implantatsystem

Scan-Bodies



		Desktop Scanbody <i>inkl. Standard-Schraube</i>	IOS Scanbody H4	IOS Scanbody H7
		 IM DOPPELPAK		
ø3,4 mm		EVO-ZI-EZ-MACH-2.9	–	–
Art-Nr.:		ZFX05002270	–	–

Komponenten-Zubehör

		Pre-Abutment Blank <i>inkl. Standard-Schraube</i>	Ersatzschraube <i>Standard-Schraube</i>	Modellanalog
			 \vec{M} Drehmoment	IM DOPPELPAK
ø3,4 mm		Pre-Abutment Blank	ZI-EZ-SCTI-2.9	30 Ncm
Art-Nr.:		ZFX18000420	ZFX09002400	–

*max. möglicher Schraubenkanal-Winkel

Komponenten-Zubehör für direkt-verschraubte Prothetik

Standard-Schraube			Sechsrund-Schraube		
	$\leq 20^\circ$			$\leq 25^\circ$	
					
		\vec{M} Drehmoment		\vec{M} Drehmoment	
ø3,4mm	ZI-EZ-SCTI-2.9	30 Ncm	Hexalobular Screw ZI-EZ	30 Ncm	
Art-Nr.:	ZFX09002400		ZFX09-ZI-EZ-HL		

Schraubendreher

	Standard-Schraube	Sechsrund-Schraube		Scanbodies
ø3,4mm	AORAKI	MERU		FUJI

 Bestellinformationen zu Schraubendrehern ab Seite 8

3i-IO Type für das Zimmer Biomet IOL® Abutmentsystem

Scan-Bodies

Desktop Scanbody *inkl. Standard-Schraube*

IM DOPPELPAK



ø 4,5 mm

EVO-3i-IO-MACH-4.5

Art-Nr.:

ZFX05002161

IOS Scanbody H4 *inkl. Standard-Schraube*

IM DOPPELPAK



INTRA-3i-IO-MACH-4.5-H4

Art-Nr.: ZFX05001927

Brücken-Versorgung

Titanbasis nicht rotationsgeschützt für Brücken *Small Design, inkl. Standard-Schraube*



S-TI-Base-3i-IO-TBUL-4.5

Art-Nr.: ZFX11002089

Komponenten-Zubehör

Pre-Abutment Blank

ø 4,5 mm

–

Art-Nr.:

–

Ersatzschraube *Standard-Schraube*



\vec{M}
Drehmoment

3i-CO-SCTI-3.4-6.0

10 Ncm

Art-Nr.: ZFX09001007

Modellanalog

IM DOPPELPAK



MC-Analog-3i-IO-4.5

Art-Nr.: ZFX15002291

Komponenten-Zubehör für direkt-verschraubte Prothetik

Standard-Schraube

≤ 20°*



\vec{M}
Drehmoment

3i-CO-SCTI-3.4-6.0

10 Ncm

Art-Nr.:

ZFX09001007

Sechsrund-Schraube

≤ 25°*



\vec{M}
Drehmoment

Hexalobular Screw 3i-CO/-IO

10 Ncm

Art-Nr.: ZFX09-3i-CO-HL

Schraubendreher

Standard-Schraube

ø 4,5 mm

AORAKI

Sechsrund-Schraube



MERU

Scanbodies

FUJI





Bestellinformationen zu Schraubendrehern ab Seite 8

*max. möglicher Schraubenkanal-Winkel



3i-LO Type für das Zimmer Biomet Low Profile® Abutmentsystem

Scan-Bodies



Brücken-Versorgung

	Desktop Scanbody <i>inkl. Standard-Schraube</i>	Desktop Scanbody rotationsgeschützt <i>inkl. Standard-Schraube</i>	IOS Scanbody H4 <i>inkl. Standard-Schraube</i>	Titanbasis nicht rotationsgeschützt <i>Small Design, inkl. Standard-Schraube</i>
	 <small>IM DOPPELPACK</small>	 <small>IM DOPPELPACK</small>	 <small>IM DOPPELPACK</small>	
ø 4,5 mm	EVO-3I-LO-MACH-4.8	EVO-3I-LO-HE-MACH-4.8	INTRA-3I-LO-MACH-4.8-H4	S-TI-Base-3I-LO-TBUL-4.8
Art-Nr.:	ZFX05002162	ZFX05002156	ZFX05001928	ZFX11002090

Komponenten-Zubehör

	Pre-Abutment Blank	Ersatzschraube <i>Standard-Schraube</i>	Modellanalog
		 <small>⌚ Drehmoment</small>	 <small>IM DOPPELPACK</small>
ø 4,5 mm	–	3I-LO-SCTI-4.8	MC-Analog-3I-LO-4.8
Art-Nr.:	–	ZFX09001008	ZFX15002292

Komponenten-Zubehör für direkt-verschraubte Prothetik

	Standard-Schraube	Sechsrund-Schraube
	≤ 20°  <small>⌚ Drehmoment</small>	≤ 25°  <small>⌚ Drehmoment</small>
ø 4,5 mm	3I-LO-SCTI-4.8	Hexalobular Screw 3I-LO
Art-Nr.:	ZFX09001008	ZFX09-3I-LO-HL



Schraubendreher

	Standard-Schraube	Sechsrund-Schraube	Scanbodies
ø 4,5 mm	AORAKI	MERU	FUJI

 Bestellinformationen zu Schraubendrehern ab Seite 8

ZI-SH Type für das Zimmer Biomet Shoulder Abutment® System

Scan-Bodies

		Desktop Scanbody <i>inkl. Standard-Schraube</i>	IOS Scanbody H4 <i>inkl. Standard-Schraube</i>	IOS Scanbody H7
				
		IM DOPPELPAK	IM DOPPELPAK	
ø 4,5 mm		EVO-ZI-SH-MACH-4.5	INTRA-ZI-SH-MACH-4.5-H4	–
Art-Nr.:		ZFX05002171	ZFX05001937	–
ø 6,5 mm		EVO-ZI-SH-MACH-6.5	INTRA-ZI-SH-MACH-6.5-H4	–
Art-Nr.:		ZFX05002172	ZFX05001938	–

Einzelkronen-Versorgung

Titanbasis rotationsgeschützt für Einzelkronen

ø 4,5 mm	–
Art-Nr.:	–
ø 6,5 mm	–
Art-Nr.:	–

Brücken-Versorgung

Titanbasis nicht rotationsgeschützt für Brücken

Small Design, inkl. Standard-Schraube



ø 4,5 mm		S-TI-Base-ZI-SH-TBUL-4.5
Art-Nr.:		ZFX11002084
ø 6,5 mm		S-TI-Base-ZI-SH-TBUL-6.5
Art-Nr.:		ZFX11002085

*max. möglicher Schraubenkanal-Winkel

Komponenten-Zubehör

Pre-Abutment Blank**Ersatzschraube**
Standard-Schraube**Modellanalog**

IM DOPPELPAK



ø 4,5 mm	–	ZI-SH-SCTI-4.5-6.5	20 Ncm	MC-Analog-ZI-SH-4.5
Art-Nr.:	–	ZFX09001006		ZFX15002306
ø 6,5 mm	–	ZI-SH-SCTI-4.5-6.5	20 Ncm	MC-Analog-ZI-SH-6.5
Art-Nr.:	–	ZFX09001006		ZFX15002307

Komponenten-Zubehör für direkt-verschraubte Prothetik

Standard-Schraube**Sechsrund-Schraube**

≤ 20°*

≤ 25°*

 \bar{M}
Drehmoment

 \bar{M}
Drehmoment

ø 4,5 mm	ZI-SH-SCTI-4.5-6.5	20 Ncm	Hexalobular Screw ZI-SH	20 Ncm
Art-Nr.:	ZFX09001006		ZFX09-ZI-SH-HL	
ø 6,5 mm	ZI-SH-SCTI-4.5-6.5	20 Ncm	Hexalobular Screw ZI-SH	20 Ncm
Art-Nr.:	ZFX09001006		ZFX09-ZI-SH-HL	

Schraubendreher



Standard-Schraube**Sechsrund-Schraube****Scanbodies**

ø 4,5 mm	FUJI	MERU	FUJI
ø 6,5 mm	FUJI	MERU	FUJI

Bestellinformationen zu Schraubendrehern ab Seite 8

ZI-SW Type für das Zimmer Biomet SwissPlus® Implantatsystem

Scan-Bodies

		Desktop Scanbody <i>inkl. Standard-Schraube</i>	IOS Scanbody H4 <i>inkl. Standard-Schraube</i>	IOS Scanbody H7 <i>inkl. Standard-Schraube</i>
				
		IM DOPPELPAK	IM DOPPELPAK	IM DOPPELPAK
ø 3,8 mm		EVO-ZI-SW-MACH-3.8	INTRA-ZI-SW-MACH-3.8-H4	INTRA-ZI-SW-MACH-3.8-H7
Art-Nr.:		ZFX05002059	ZFX05002014	ZFX05002015
ø 4,8 mm		EVO-ZI-SW-MACH-4.8	NTRA-ZI-SW-MACH-4.8-H4	INTRA-ZI-SW-MACH-4.8-H7
Art-Nr.:		ZFX05002060	ZFX05002016	ZFX05002017

Einzelkronen-Versorgung

Titanbasis rotationsgeschützt für Einzelkronen *Small Design, inkl. Standard-Schraube*



ø 3,8 mm	S-TI-Base-ZI-SW-TBLO-3.8
Art-Nr.:	ZFX11001160
ø 4,8 mm	S-TI-Base-ZI-SW-TBLO-4.8
Art-Nr.:	ZFX11001161

Brücken-Versorgung

Titanbasis nicht rotationsgeschützt für Brücken *Small Design, inkl. Standard-Schraube*



ø 3,8 mm	S-TI-Base-ZI-SW-TBUL-3.8
Art-Nr.:	ZFX11001162
ø 4,8 mm	S-TI-Base-ZI-SW-TBUL-4.8
Art-Nr.:	ZFX11001163

*max. möglicher Schraubenkanal-Winkel

Komponenten-Zubehör

Pre-Abutment Blank**Ersatzschraube**
Standard-Schraube**Modellanalog**

IM DOPPELPAK

 \vec{M}
Drehmoment

ø 3,8 mm	–	ZI-SW-SCTI-3.8	30 Ncm	MC-Analog-ZI-SW-3.8
Art-Nr.:	–	ZFX09000987		ZFX15002155
ø 4,8 mm	–	ZI-SW-SCTI-4.8	30 Ncm	MC-Analog-ZI-SW-4.8
Art-Nr.:	–	ZFX09000988		ZFX15002156

Komponenten-Zubehör für direkt-verschraubte Prothetik

Standard-Schraube**Sechsrund-Schraube**

≤ 20°*

≤ 25°*

 \vec{M}
Drehmoment

 \vec{M}
Drehmoment

ø 3,8 mm	ZI-SW-SCTI-3.8	30 Ncm	Hexalobular Screw ZI-SC, ZI-SW-3.8	30 Ncm
Art-Nr.:	ZFX09000987		ZFX09-ZI-SC-HL	
ø 4,8 mm	ZI-SW-SCTI-4.8	30 Ncm	Hexalobular Screw ZI-SW-4.8	30 Ncm
Art-Nr.:	ZFX09000988		ZFX09-ZI-SW-48-HL	

Schraubendreher



Standard-Schraube**Sechsrund-Schraube****Scanbodies**

ø 3,8 mm	FUJI	MERU	FUJI
ø 4,8 mm	FUJI	MERU	FUJI

Bestellinformationen zu Schraubendrehern ab Seite 8





ZI-SC Type für das Zimmer Biomet Tapered Screw-Vent® Implantatsystem

Scan-Bodies

		Desktop Scanbody <i>inkl. Standard-Schraube</i>	IOS Scanbody H4 <i>inkl. Standard-Schraube</i>	IOS Scanbody H7 <i>inkl. Standard-Schraube</i>
				
		IM DOPPELPAK	IM DOPPELPAK	IM DOPPELPAK
ø 3,5 mm		EVO-ZI-SC-MACH-3.5	INTRA-ZI-SC-MACH-3.5-H4	INTRA-ZI-SC-MACH-3.5-H7
Art-Nr.:		ZFX05002056	ZFX05001090	ZFX05001093
ø 4,5 mm		EVO-ZI-SC-MACH-4.5	INTRA-ZI-SC-MACH-4.5-H4	INTRA-ZI-SC-MACH-4.5-H7
Art-Nr.:		ZFX05002057	ZFX05001091	ZFX05001094
ø 5,7 mm		EVO-ZI-SC-MACH-5.7	INTRA-ZI-SC-MACH-5.7-H4	INTRA-ZI-SC-MACH-5.7-H7
Art-Nr.:		ZFX05002058	ZFX05001092	ZFX05001095

Einzelkronen-Versorgung

Brücken-Versorgung

		Titanbasis rotationsgeschützt für Einzelkronen <i>Regular Design, inkl. Standard-Schraube Small Design, inkl. Standard-Schraube</i>		Titanbasis nicht rotationsgeschützt für Brücken <i>Regular Design, inkl. Standard-Schraube Small Design, inkl. Standard-Schraube</i>	
					
ø 3,5 mm		TI-Base-ZI-SC-TBLO-3.5	S-TI-Base-ZI-SC-TBLO-3.5	TI-Base-ZI-SC-TBUL-3.5	S-TI-Base-ZI-SC-TBUL-3.5
Art-Nr.:		ZFX11000745	ZFX11001154	ZFX11000748	ZFX11001157
ø 4,5 mm		TI-Base-ZI-SC-TBLO-4.5	S-TI-Base-ZI-SC-TBLO-4.5	TI-Base-ZI-SC-TBUL-4.5	S-TI-Base-ZI-SC-TBUL-4.5
Art-Nr.:		ZFX11000746	ZFX11001155	ZFX11000749	ZFX11001158
ø 5,7 mm		TI-Base-ZI-SC-TBLO-5.7	S-TI-Base-ZI-SC-TBLO-5.7	TI-Base-ZI-SC-TBUL-5.7	S-TI-Base-ZI-SC-TBUL-5.7
Art-Nr.:		ZFX11000747	ZFX11001156	ZFX11000750	ZFX11001159

*max. möglicher Schraubenkanal-Winkel

Komponenten-Zubehör

Pre-Abutment Blank
inkl. Standard-Schraube**Ersatzschraube**
Standard-Schraube
 \vec{M}
Drehmoment
Modellanalog

IM DOPPELPAK

ø 3,5 mm	Pre-Abutment Blank	ZI-SC-SCTI-3.5-5.7	30 Ncm	MC-Analog-ZI-SC-3.5
Art-Nr.:	ZFX18000390	ZFX09000655		ZFX15002152
ø 4,5 mm	Pre-Abutment Blank	ZI-SC-SCTI-3.5-5.7	30 Ncm	MC-Analog-ZI-SC-4.5
Art-Nr.:	ZFX18000400	ZFX09000655		ZFX15002153
ø 5,7 mm	Pre-Abutment Blank	ZI-SC-SCTI-3.5-5.7	30 Ncm	MC-Analog-ZI-SC-5.7
Art-Nr.:	ZFX18000410	ZFX09000655		ZFX15002154

Komponenten-Zubehör für direkt-verschraubte Prothetik

Standard-Schraube

≤ 20°*

 \vec{M}
Drehmoment
Sechsrund-Schraube

≤ 25°*

 \vec{M}
Drehmoment

ø 3,5 mm	ZI-SC-SCTI-3.5-5.7	30 Ncm	Hexalobular Screw ZI-SC, ZI-SW-3.8	30 Ncm
Art-Nr.:	ZFX09000655		ZFX09-ZI-SC-HL	
ø 4,5 mm	ZI-SC-SCTI-3.5-5.7	30 Ncm	Hexalobular Screw ZI-SC, ZI-SW-3.8	30 Ncm
Art-Nr.:	ZFX09000655		ZFX09-ZI-SC-HL	
ø 5,7 mm	ZI-SC-SCTI-3.5-5.7	30 Ncm	Hexalobular Screw ZI-SC, ZI-SW-3.8	30 Ncm
Art-Nr.:	ZFX09000655		ZFX09-ZI-SC-HL	

Schraubendreher

Standard-Schraube**Sechsrund-Schraube****Scanbodies**

ø 3,5 mm	FUJI	MERU	FUJI
ø 4,5 mm	FUJI	MERU	FUJI
ø 5,7 mm	FUJI	MERU	FUJI

Bestellinformationen zu Schraubendrehern ab Seite 8

ZI-TA Type für das Zimmer Biomet Tapered Abutment® System

Scan-Bodies

Desktop Scanbody *inkl. Standard-Schraube*

IM DOPPELPAK



ø 4,5 mm

EVO-ZI-TA-MACH-4.5

Art-Nr.:

ZFX05002157

IOS Scanbody H4 *inkl. Standard-Schraube*

IM DOPPELPAK



INTRA-ZI-TA-MACH-4.5-H4

Art-Nr.: ZFX05001924

Brücken-Versorgung

Titanbasis nicht rotationsgeschützt für Brücken *Small Design, inkl. Standard-Schraube*



S-TI-Base-ZI-TA-TBUL-4.5

Art-Nr.: ZFX11002078

Komponenten-Zubehör

Pre-Abutment Blank

ø 4,5 mm

–

Art-Nr.:

–

Ersatzschraube *Standard-Schraube*



\vec{M}
Drehmoment

ZI-TA-SCTI-4.5

20 Ncm

Art-Nr.: ZFX09000657

Modellanalog

IM DOPPELPAK



MC-Analog-ZI-TA-4.5

Art-Nr.: ZFX15002305

Komponenten-Zubehör für direkt-verschraubte Prothetik

Standard-Schraube

≤ 20°*



\vec{M}
Drehmoment

ø 4,5 mm

ZI-TA-SCTI-4.5

20 Ncm

Art-Nr.:

ZFX09000657

Sechsrund-Schraube

≤ 25°*



\vec{M}
Drehmoment

Hexalobular Screw ZI-TA

20 Ncm

Art-Nr.: ZFX09-ZI-TA-HL

Schraubendreher

Standard-Schraube

ø 4,5 mm

FUJI

Sechsrund-Schraube



MERU

Scanbodies

FUJI

Bestellinformationen zu Schraubendrehern ab Seite 8

* max. möglicher Schraubenkanal-Winkel

AN-AX Type für das Anthogyr Axiom® Implantatsystem

Scan-Bodies

	Desktop Scanbody <i>inkl. Standard-Schraube</i>	IOS Scanbody H4	IOS Scanbody H7
			
ø 3,4 / 6,0 mm	EVO-AN-AX-MACH-3.4-6.0	–	–
Art-Nr.:	ZFX05002205	–	–

Schraubendreher



	Standard-Schraube	Sechsrund-Schraube 	Scanbodies
ø 3,4 / 6,0 mm	AORAKI	–	FUJI
 Bestellinformationen zu Schraubendrehern ab Seite 8			

AN-MU Type für das Anthogyr Multi Unit® Abutmentsystem

Scan-Bodies

	Desktop Scanbody <i>inkl. Standard-Schraube</i>	IOS Scanbody H4	IOS Scanbody H7
	 IM DOPPELPAK		
ø 4,8 mm	EVO-AN-MU-MACH-4.8	–	–
Art-Nr.:	ZFX05002206	–	–

Schraubendreher

	Standard-Schraube	Sechsrund-Schraube 	Scanbodies
ø 4,8 mm	FUJI	–	FUJI
 Bestellinformationen zu Schraubendrehern ab Seite 8			

BD-CO Type für das Biotech Dental Conical abutment® System

Scan-Bodies

	Desktop Scanbody <i>inkl. Standard-Schraube</i>	IOS Scanbody H4	IOS Scanbody H7
	 IM DOPPELPAK		
ø 4,9 mm	EVO-BD-CO-MACH-4.9	–	–
Art-Nr.:	ZFX05002208	–	–

Schraubendreher

	Standard-Schraube		Scanbodies
ø 4,9 mm	AORAKI	–	FUJI
 Bestellinformationen zu Schraubendrehern ab Seite 8			

BD-KO Type für das Biotech Dental Kontakt® Implantatsystem

Scan-Bodies

	Desktop Scanbody <i>inkl. Standard-Schraube</i>	IOS Scanbody H4	IOS Scanbody H7
	 IM DOPPELPAK		
ø 3,6 / 5,4 mm	EVO-BD-KO-MACH-3.6-5.4	–	–
Art-Nr.:	ZFX05002207	–	–



Schraubendreher

	Standard-Schraube		Scanbodies
ø 3,6 / 5,4 mm	AORAKI		FUJI
 Bestellinformationen zu Schraubendrehern ab Seite 8			

*max. möglicher Schraubenkanal-Winkel

BH-IN Type für das BioHorizons Internal® Implantatsystem

Scan-Bodies

		Desktop Scanbody <i>inkl. Standard-Schraube</i>	IOS Scanbody H4 <i>inkl. Standard-Schraube</i>	IOS Scanbody H7 <i>inkl. Standard-Schraube</i>
		 IM DOPPELPACK	 IM DOPPELPACK	 IM DOPPELPACK
ø 3,0 mm	EVO-BH-IN-MACH-3.0	INTRA-BH-IN-MACH-3.0-H4	INTRA-BH-IN-MACH-3.0-H7	
Art-Nr.:	ZFX05D-BH-IN-30	ZFX05I-BH-IN-30-H4	ZFX05I-BH-IN-30-H7	
ø 3,5 mm	EVO-BH-IN-MACH-3.5	INTRA-BH-IN-MACH-3.5-H4	INTRA-BH-IN-MACH-3.5-H7	
Art-Nr.:	ZFX05002282	ZFX05002285	ZFX05002288	
ø 4,5 mm	EVO-BH-IN-MACH-4.5	INTRA-BH-IN-MACH-4.5-H4	INTRA-BH-IN-MACH-4.5-H7	
Art-Nr.:	ZFX05002283	ZFX05002286	ZFX05002289	
ø 5,7 mm	EVO-BH-IN-MACH-5.7	INTRA-BH-IN-MACH-5.7-H4	INTRA-BH-IN-MACH-5.7-H7	
Art-Nr.:	ZFX05002284	ZFX05002287	ZFX05002290	

Komponenten-Zubehör

		Pre-Abutment Blank	Ersatzschraube <i>Standard-Schraube</i>	Modellanalog
			$\leq 25^\circ$	 IM DOPPELPACK
ø 3,0 mm	–	TI-Screw-BH-IN	30 Ncm	–
Art-Nr.:	–	ZFX09-BH-IN-HL		–
ø 3,5 mm	–	TI-Screw-BH-IN	30 Ncm	MC-Analog-BH-IN-3.5
Art-Nr.:	–	ZFX09-BH-IN-HL		ZFX15002331
ø 4,5 mm	–	TI-Screw-BH-IN	30 Ncm	MC-Analog-BH-IN-4.5
Art-Nr.:	–	ZFX09-BH-IN-HL		ZFX15002332
ø 5,7 mm	–	TI-Screw-BH-IN	30 Ncm	MC-Analog-BH-IN-5.7
Art-Nr.:	–	ZFX09-BH-IN-HL		ZFX15002333



Schraubendreher

		Standard-Schraube	Sechsrund-Schraube 	Scanbodies
ø 3,0 mm	FUJI	–	FUJI	
ø 3,5 mm	FUJI	–	FUJI	
ø 4,5 mm	FUJI	–	FUJI	
ø 5,7 mm	FUJI	–	FUJI	



 Bestellinformationen zu Schraubendrehern ab Seite 8

BH-MU Type für das BioHorizons Multi-Unit® Implantatsystem

Scan-Bodies

	Desktop Scanbody <i>inkl. Standard-Schraube</i>	IOS Scanbody H4 <i>inkl. Standard-Schraube</i>	IOS Scanbody H7
	 IM DOPPELPACK	 IM DOPPELPACK	
∅ 4,8 mm	EVO-BH-MU-MACH-4.8	INTRA-BH-MU-MACH-4.8-H4	–
Art-Nr.:	ZFX05D-BH-MU-48	ZFX05I-BH-MU-48-H4	–

Schraubendreher

	Standard-Schraube	Sechsrund-Schraube 	Scanbodies
∅ 4,8 mm	FUJI	–	FUJI
 Bestellinformationen zu Schraubendrehern ab Seite 8			

*max. möglicher Schraubenkanal-Winkel

BR-MU Type für das Bredent SKY uni.cone® / SKY fast and fixed® Abutmentsystem

Scan-Bodies

Desktop Scanbody *inkl. Standard-Schraube*

IM DOPPELPACK



IOS Scanbody H4 *inkl. Standard-Schraube*

IM DOPPELPACK



Brücken-Versorgung

Titanbasis nicht rotationsgeschützt für Brücken *Small Design, inkl. Standard-Schraube*



ø 4,5 mm	EVO-BR-MU-MACH-4.5	INTRA-BR-MU-MACH-4.5-H4	S-TI-Base-BR-MU-TBUL-4.5
Art-Nr.:	ZFX05002061	ZFX05001150	ZFX11002199
ø 5,6 mm	EVO-BR-MU-MACH-5.6	INTRA-BR-MU-MACH-5.6-H4	S-TI-Base-BR-MU-TBUL-5.6
Art-Nr.:	ZFX05002179	ZFX05001939	ZFX11002196

Komponenten-Zubehör

Pre-Abutment Blank

Ersatzschraube *Standard-Schraube*

Modellanalog

≤ 25°*

 \vec{M}
Drehmoment

IM DOPPELPACK

ø 4,5 mm	–	BR-MU-SCTI-4.5-5.6	18 Ncm	MC-Analog-BR-MU-4.5
Art-Nr.:	–	ZFX09002186		ZFX15002329
ø 5,6 mm	–	BR-MU-SCTI-4.5-5.6	18 Ncm	MC-Analog-BR-MU-5.6
Art-Nr.:	–	ZFX09002186		ZFX15002330

Schraubendreher

Standard-Schraube

Sechsrund-Schraube





Scanbodies

ø 4,5 mm	JORASSES	–	FUJI
ø 5,6 mm	JORASSES	–	FUJI

Bestellinformationen zu Schraubendrehern ab Seite 8



BR-SK Type für das Bredent SKY® Implantatsystem

Scan-Bodies

		Desktop Scanbody <i>inkl. Standard-Schraube</i>	IOS Scanbody H4 <i>inkl. Standard-Schraube</i>	IOS Scanbody H7 <i>inkl. Standard-Schraube</i>
				
		IM DOPPELPACK	IM DOPPELPACK	IM DOPPELPACK
ø 3,5 mm		EVO-BR-SK-MACH-3.5	INTRA-BR-SK-MACH-3.5-H4	INTRA-BR-SK-MACH-3.5-H7
Art-Nr.:		ZFX05002256	ZFX05001132	ZFX05001133
ø 4,0 mm		EVO-BR-SK-MACH-4.0	INTRA-BR-SK-MACH-4.0-H4	INTRA-BR-SK-MACH-4.0-H7
Art-Nr.:		ZFX05002178	ZFX05001102	ZFX05001103

Einzelkronen-Versorgung

Brücken-Versorgung

		Titanbasis rotationsgeschützt für Einzelkronen <i>Small Design, inkl. Standard-Schraube</i>	Titanbasis nicht rotationsgeschützt für Brücken <i>Small Design, inkl. Standard-Schraube</i>
			
ø 3,5 mm		S-TI-Base-BR-SK-TBLO-3.5	S-TI-Base-BR-SK-TBUL-3.5
Art-Nr.:		ZFX11002205	ZFX11002207
ø 4,0 mm		S-TI-Base-BR-SK-TBLO-4.0	S-TI-Base-BR-SK-TBUL-4.0
Art-Nr.:		ZFX11002194	ZFX11002195

*max. möglicher Schraubenkanal-Winkel

Komponenten-Zubehör

Pre-Abutment Blank**Ersatzschraube**
Standard-Schraube**Modellanalog**

IM DOPPELPAK

 \vec{M}
Drehmoment

ø 3,5 mm	–	BR-SK-SCTI-3.5-4.0	25 Ncm	MC-Analog-BR-SK-3.5
Art-Nr.:	–	ZFX09002185		ZFX15002327
ø 4,0 mm	–	BR-SK-SCTI-3.5-4.0	25 Ncm	MC-Analog-BR-SK-4.0
Art-Nr.:	–	ZFX09002185		ZFX15002328

Komponenten-Zubehör für direkt-verschraubte Prothetik

Standard-Schraube**Sechsrund-Schraube**

≤ 25°*

 \vec{M}
Drehmoment

ø 3,5 mm	BR-SK-SCTI-3.5-4.0	25 Ncm	–	
Art-Nr.:	ZFX09002185		–	
ø 4,0 mm	BR-SK-SCTI-3.5-4.0	25 Ncm	–	
Art-Nr.:	ZFX09002185		–	

Schraubendreher

Standard-Schraube**Sechsrund-Schraube****Scanbodies**

ø 3,5 mm	JORASSES	–	FUJI
ø 4,0 mm	JORASSES	–	FUJI

Bestellinformationen zu Schraubendrehern ab Seite 8

CA-CA Type für das Camlog Screw-Line® Implantatsystem

Scan-Bodies

Desktop Scanbody *inkl. Standard-Schraube*

IM DOPPELPAK



IOS Scanbody H4 *inkl. Standard-Schraube*

IM DOPPELPAK



IOS Scanbody H7 *inkl. Standard-Schraube*

IM DOPPELPAK



ø 3,3 mm	EVO-CA-CA-MACH-3.3	INTRA-CA-CA-MACH-3.3-H4	INTRA-CA-CA-MACH-3.3-H7
Art-Nr.:	ZFX05002029	ZFX05001964	ZFX05001965
ø 3,8 mm	EVO-CA-CA-MACH-3.8	INTRA-CA-CA-MACH-3.8-H4	INTRA-CA-CA-MACH-3.8-H7
Art-Nr.:	ZFX05002030	ZFX05001966	ZFX05001967
ø 4,3 mm	EVO-CA-CA-MACH-4.3	INTRA-CA-CA-MACH-4.3-H4	INTRA-CA-CA-MACH-4.3-H7
Art-Nr.:	ZFX05002031	ZFX05001968	ZFX05001969
ø 5,0 mm	EVO-CA-CA-MACH-5.0	INTRA-CA-CA-MACH-5.0-H4	INTRA-CA-CA-MACH-5.0-H7
Art-Nr.:	ZFX05002032	ZFX05001970	ZFX05001971
ø 6,0 mm	EVO-CA-CA-MACH-6.0	INTRA-CA-CA-MACH-6.0-H4	INTRA-CA-CA-MACH-6.0-H7
Art-Nr.:	ZFX05002033	ZFX05001972	ZFX05001973

Einzelkronen-Versorgung

Titanbasis rotationsgeschützt für Einzelkronen

Brücken-Versorgung



Titanbasis nicht rotationsgeschützt für Brücken *Small Design, inkl. Standard-Schraube*





ø 3,3 mm	-	S-TI-Base-CA-CA-TBUL-3.3
Art-Nr.:	-	ZFX11002208
ø 3,8 mm	-	S-TI-Base-CA-CA-TBUL-3.8
Art-Nr.:	-	ZFX11002209
ø 4,3 mm	-	S-TI-Base-CA-CA-TBUL-4.3
Art-Nr.:	-	ZFX11002210
ø 5,0 mm	-	S-TI-Base-CA-CA-TBUL-5.0
Art-Nr.:	-	ZFX11002211
ø 6,0 mm	-	S-TI-Base-CA-CA-TBUL-6.0
Art-Nr.:	-	ZFX11002212

*max. möglicher Schraubenkanal-Winkel

Komponenten-Zubehör

Pre-Abutment Blank		Ersatzschraube Standard-Schraube		Modellanalog	
					IM DOPPELPACK
					
			\vec{M} Drehmoment		
ø 3,3 mm	–	CA-CA-SCTI-3.3-4.3	20 Ncm	MC-Analog-CA-CA-3.3	
Art-Nr.:	–	ZFX09002323		ZFX15002127	
ø 3,8 mm	–	CA-CA-SCTI-3.3-4.3	20 Ncm	MC-Analog-CA-CA-3.8	
Art-Nr.:	–	ZFX09002323		ZFX15002128	
ø 4,3 mm	–	CA-CA-SCTI-3.3-4.3	20 Ncm	MC-Analog-CA-CA-4.3	
Art-Nr.:	–	ZFX09002323		ZFX15002129	
ø 5,0 mm	–	CA-CA-SCTI-5.0-6.0	20 Ncm	MC-Analog-CA-CA-5.0	
Art-Nr.:	–	ZFX09002324		ZFX15002130	
ø 6,0 mm	–	CA-CA-SCTI-5.0-6.0	20 Ncm	MC-Analog-CA-CA-6.0	
Art-Nr.:	–	ZFX09002324		ZFX15002131	

Komponenten-Zubehör für direkt-verschraubte Prothetik

Standard-Schraube		Sechsrund-Schraube	
			
	≤ 20°*		
			\vec{M} Drehmoment
ø 3,3 mm	CA-CA-SCTI-3.3-4.3	20 Ncm	–
Art-Nr.:	ZFX09002323		–
ø 3,8 mm	CA-CA-SCTI-3.3-4.3	20 Ncm	–
Art-Nr.:	ZFX09002323		–
ø 4,3 mm	CA-CA-SCTI-3.3-4.3	20 Ncm	–
Art-Nr.:	ZFX09002323		–
ø 5,0 mm	CA-CA-SCTI-5.0-6.0	20 Ncm	–
Art-Nr.:	ZFX09002324		–
ø 6,0 mm	CA-CA-SCTI-5.0-6.0	20 Ncm	–
Art-Nr.:	ZFX09002324		–

Schraubendreher

Standard-Schraube	Sechsrund-Schraube		Scanbodies
ø 3,3 mm	FUJI	–	FUJI
ø 3,8 mm	FUJI	–	FUJI
ø 4,3 mm	FUJI	–	FUJI
ø 5,0 mm	FUJI	–	FUJI
ø 6,0 mm	FUJI	–	FUJI

 Bestellinformationen zu Schraubendrehern ab Seite 8

CA-VA Type für das Camlog VARIO SR® Abutment System

Scan-Bodies

Desktop Scanbody *inkl. Standard-Schraube*

IM DOPPELPACK



IOS Scanbody H4 *inkl. Standard-Schraube*

IM DOPPELPACK



Einzelkronen-Versorgung

Titanbasis rotationsgeschützt für Einzelkronen *Small Design, inkl. Standard-Schraube*



ø 3,8 / 4,3 mm	EVO-CA-VA-MACH-3.8-4.3	INTRA-CA-VA-MACH-3.8-4.3-H4	S-TI-Base-CA-VA-TBUL-3.8-4.3
Art-Nr.:	ZFX05002180	ZFX05001940	ZFX11002197
ø 5,0 / 6,0 mm	EVO-CA-VA-MACH-5.0-6.0	INTRA-CA-VA-MACH-5.0-6.0-H4	S-TI-Base-CA-VA-TBUL-5.0-6.0
Art-Nr.:	ZFX05002181	ZFX05001941	ZFX11002198

Komponenten-Zubehör

Pre-Abutment Blank

Ersatzschraube *Standard-Schraube*

Modellanalog

IM DOPPELPACK



\vec{M}
Drehmoment



ø 3,8 / 4,3 mm	–	CA-VA-SCTI-3.8-6.0	15 Ncm	MC-Analog-CA-VA-3.8-4.3
Art-Nr.:	–	ZFX09002187		ZFX15002295
ø 5,0 / 6,0 mm	–	CA-VA-SCTI-3.8-6.0	15 Ncm	MC-Analog-CA-VA-5.0-6.0
Art-Nr.:	–	ZFX09002187		ZFX15002296

Komponenten-Zubehör für direkt-verschraubte Prothetik

Standard-Schraube

Sechsrund-Schraube

≤ 20°*

≤ 25°*



\vec{M}
Drehmoment



\vec{M}
Drehmoment

ø 3,8 / 4,3 mm	CA-VA-SCTI-3.8-6.0	15 Ncm		Ncm
Art-Nr.:	ZFX09002187			
ø 5,0 / 6,0 mm	CA-VA-SCTI-3.8-6.0	15 Ncm		
Art-Nr.:	ZFX09002187			

Schraubendreher

Standard-Schraube

Scanbodies

ø 3,8 / 4,3 mm	FUJI	–	FUJI
ø 5,0 / 6,0 mm	FUJI	–	FUJI

Bestellinformationen zu Schraubendrehern ab Seite 8

* max. möglicher Schraubenkanal-Winkel

DU-SU Type für das Dentium Superline & Implantium® Implantatsystem

Scan-Bodies

Desktop Scanbody inkl. Standard-Schraube



IM DOPPELPAK

ø3,6/7,0mm	EVO-DU-SU-MACH-3.6-7.0		
Art-Nr.:	ZFX05002200		

Schraubendreher

Standard-Schraube

Scanbodies

ø3,6/7,0mm	FUJI		FUJI
-------------------	------	--	------

 Bestellinformationen zu Schraubendrehern ab Seite 8

DU-SA Type für das Dentium Screw Abutment® Implantatsystem

Scan-Bodies

Desktop Scanbody inkl. Standard-Schraube



IM DOPPELPAK

IOS Scanbody H4 inkl. Standard-Schraube



IM DOPPELPAK

ø4,5/5,5mm	EVO-DU-SA-MACH-4.5-5.5	INTRA-DU-SA-MACH-4.5-5.5-H4	
Art-Nr.:	ZFX05D-DU-SA-4555	ZFX05I-DU-SA-4555-H4	

Schraubendreher

Standard-Schraube

Scanbodies

ø4,5/5,5mm	FUJI		FUJI
-------------------	------	--	------



 Bestellinformationen zu Schraubendrehern ab Seite 8

AS-EV Type für das Dentsply Implants (Astratech) EV® Implantatsystem

Scan-Bodies



		Desktop Scanbody <i>inkl. Standard-Schraube</i>	IOS Scanbody H4	IOS Scanbody H7
				
		<small>IM DOPPELPAK</small>		
ø 3,0 mm		EVO-AS-EV-MACH-3.0	–	–
Art-Nr.:		ZFX05002186	–	–
ø 3,6 mm		EVO-AS-EV-MACH-3.6	–	–
Art-Nr.:		ZFX05002188	–	–
ø 4,2 mm		EVO-AS-EV-MACH-4.2	–	–
Art-Nr.:		ZFX05002190	–	–
ø 4,8 mm		EVO-AS-EV-MACH-4.8	–	–
Art-Nr.:		ZFX05002192	–	–
ø 5,4 mm		EVO-AS-EV-MACH-5.4	–	–
Art-Nr.:		ZFX05002194	–	–

Komponenten-Zubehör

		Pre-Abutment Blank <i>inkl. Standard-Schraube</i>	Ersatzschraube <i>Standard-Schraube</i>		
					
			<small>M Drehmoment</small>		
ø 3,0 mm		Pre-Abutment Blank	AS-EV-SCTI-3.0	25 Ncm	–
Art-Nr.:		ZFX18000300	ZFX09002330		–
ø 3,6 mm		Pre-Abutment Blank	AS-EV-SCTI-3.6	25 Ncm	–
Art-Nr.:		ZFX18000310	ZFX09002331		–
ø 4,2 mm		Pre-Abutment Blank	AS-EV-SCTI-4.2	25 Ncm	–
Art-Nr.:		ZFX18000320	ZFX09002332		–
ø 4,8 mm		Pre-Abutment Blank	AS-EV-SCTI-4.8-5.4	25 Ncm	–
Art-Nr.:		ZFX18000330	ZFX09002333		–
ø 5,4 mm		Pre-Abutment Blank	AS-EV-SCTI-4.8-5.4	25 Ncm	–
Art-Nr.:		ZFX18000340	ZFX09002333		–

*max. möglicher Schraubenkanal-Winkel

Komponenten-Zubehör für direkt-verschraubte Prothetik

		<i>Standard-Schraube</i>		<i>Sechsrund-Schraube</i>		
						
		$\leq 20^\circ$				
						
ø 3,0 mm		AS-EV-SCTI-3.0	25 Ncm	–		
Art-Nr.:		ZFX09002330		–		
ø 3,6 mm		AS-EV-SCTI-3.6	25 Ncm	–		
Art-Nr.:		ZFX09002331		–		
ø 4,2 mm		AS-EV-SCTI-4.2	25 Ncm	–		
Art-Nr.:		ZFX09002332		–		
ø 4,8 mm		AS-EV-SCTI-4.8-5.4	25 Ncm	–		
Art-Nr.:		ZFX09002333		–		
ø 5,4 mm		AS-EV-SCTI-4.8-5.4	25 Ncm	–		
Art-Nr.:		ZFX09002333		–		

Schraubendreher

	<i>Standard-Schraube</i>	<i>Sechsrund-Schraube</i>		<i>Scanbodies</i>
ø 3,0 mm	FUJI	–		FUJI
ø 3,6 mm	FUJI	–		FUJI
ø 4,2 mm	FUJI	–		FUJI
ø 4,8 mm	FUJI	–		FUJI
ø 5,4 mm	FUJI	–		FUJI

 Bestellinformationen zu Schraubendrehern ab Seite 8

DE-XI Type für das Dentsply Implants Frialit-Xive® Implantatsystem

Scan-Bodies

Desktop Scanbody
inkl. Standard-Schraube

IM DOPPELPAK



IOS Scanbody H4
inkl. Standard-Schraube

IM DOPPELPAK



IOS Scanbody H7
inkl. Standard-Schraube

IM DOPPELPAK



ø 3,0 mm	EVO-DE-XI-MACH-3.0	INTRA-DE-XI-MACH-3.0-H4	INTRA-DE-XI-MACH-3.0-H7
Art-Nr.:	ZFX05002034	ZFX05001974	ZFX05001975
ø 3,4 mm	EVO-DE-XI-MACH-3.4	INTRA-DE-XI-MACH-3.4-H4	INTRA-DE-XI-MACH-3.4-H7
Art-Nr.:	ZFX05002035	ZFX05001976	ZFX05001977
ø 3,8 mm	EVO-DE-XI-MACH-3.8	INTRA-DE-XI-MACH-3.8-H4	INTRA-DE-XI-MACH-3.8-H7
Art-Nr.:	ZFX05002036	ZFX05001978	ZFX05001979
ø 4,5 mm	EVO-DE-XI-MACH-4.5	INTRA-DE-XI-MACH-4.5-H4	INTRA-DE-XI-MACH-4.5-H7
Art-Nr.:	ZFX05002037	ZFX05001980	ZFX05001981
ø 5,5 mm	EVO-DE-XI-MACH-5.5	INTRA-DE-XI-MACH-5.5-H4	INTRA-DE-XI-MACH-5.5-H7
Art-Nr.:	ZFX05002038	ZFX05001982	ZFX05001983
ø 6,5 mm	EVO-DE-XI-MACH-6.5	INTRA-DE-XI-MACH-6.5-H4	INTRA-DE-XI-MACH-6.5-H7
Art-Nr.:	ZFX05002039	ZFX05001984	ZFX05001985

Einzelkronen-Versorgung

Brücken-Versorgung

Titanbasis rotationsgeschützt für Einzelkronen

Regular Design, inkl. Standard-Schraube Small Design, inkl. Standard-Schraube

Titanbasis nicht rotationsgeschützt für Brücken

Regular Design, inkl. Standard-Schraube Small Design, inkl. Standard-Schraube



ø 3,0 mm	–	S-TI-Base-DE-XI-TBLO-3.0	–	S-TI-Base-DE-XI-TBUL-3.0
Art-Nr.:	–	ZFX11000696	–	ZFX11000702
ø 3,4 mm	TI-Base-DE-XI-TBLO-3.4	S-TI-Base-DE-XI-TBLO-3.4	TI-Base-DE-XI-TBUL-3.4	S-TI-Base-DE-XI-TBUL-3.4
Art-Nr.:	ZFX11000697	ZFX11001119	ZFX11000703	ZFX11001125
ø 3,8 mm	TI-Base-DE-XI-TBLO-3.8	S-TI-Base-DE-XI-TBLO-3.8	TI-Base-DE-XI-TBUL-3.8	S-TI-Base-DE-XI-TBUL-3.8
Art-Nr.:	ZFX11000698	ZFX11001120	ZFX11000704	ZFX11001126
ø 4,5 mm	TI-Base-DE-XI-TBLO-4.5	S-TI-Base-DE-XI-TBLO-4.5	TI-Base-DE-XI-TBUL-4.5	S-TI-Base-DE-XI-TBUL-4.5
Art-Nr.:	ZFX11000699	ZFX11001121	ZFX11000705	ZFX11001127
ø 5,5 mm	TI-Base-DE-XI-TBLO-5.5	S-TI-Base-DE-XI-TBLO-5.5	TI-Base-DE-XI-TBUL-5.5	S-TI-Base-DE-XI-TBUL-5.5
Art-Nr.:	ZFX11000700	ZFX11001122	ZFX11000706	ZFX11001128
ø 6,5 mm	–	S-TI-Base-DE-XI-TBLO-6.5	–	S-TI-Base-DE-XI-TBUL-6.5
Art-Nr.:	–	ZFX11000701	–	ZFX11000707

* max. möglicher Schraubenkanal-Winkel

Komponenten-Zubehör

Pre-Abutment Blank
inkl. Standard-Schraube**Ersatzschraube**
Standard-Schraube**Modellanalog**

IM DOPPELPAK

 \vec{M}
Drehmoment

ø 3,0 mm	Pre-Abutment Blank	DE-XI-SCTI-3.0	24 Ncm	MC-Analog-DE-XI-3.0
Art-Nr.:	ZFX18000260	ZFX09000620		ZFX15002132
ø 3,4 mm	Pre-Abutment Blank	DE-XI-SCTI-3.4-6.5	24 Ncm	MC-Analog-DE-XI-3.4
Art-Nr.:	ZFX18000270	ZFX09000621		ZFX15002133
ø 3,8 mm	Pre-Abutment Blank	DE-XI-SCTI-3.4-6.5	24 Ncm	MC-Analog-DE-XI-3.8
Art-Nr.:	ZFX18000280	ZFX09000621		ZFX15002134
ø 4,5 mm	Pre-Abutment Blank	DE-XI-SCTI-3.4-6.5	24 Ncm	MC-Analog-DE-XI-4.5
Art-Nr.:	ZFX18000290	ZFX09000621		ZFX15002135
ø 5,5 mm	Pre-Abutment Blank	DE-XI-SCTI-3.4-6.5	24 Ncm	MC-Analog-DE-XI-5.5
Art-Nr.:	ZFX18000290	ZFX09000621		ZFX15002136
ø 6,5 mm	Pre-Abutment Blank	DE-XI-SCTI-3.4-6.5	24 Ncm	-
Art-Nr.:	ZFX18000290	ZFX09000621		-

Komponenten-Zubehör für direkt-verschraubte Prothetik

Standard-Schraube**Sechsrund-Schraube**

≤ 20°*

 \vec{M}
Drehmoment

ø 3,0 mm	DE-XI-SCTI-3.0	24 Ncm	-	
Art-Nr.:	ZFX09000620		-	
ø 3,4 mm	DE-XI-SCTI-3.4-6.5	24 Ncm	-	
Art-Nr.:	ZFX09000621		-	
ø 3,8 mm	DE-XI-SCTI-3.4-6.5	24 Ncm	-	
Art-Nr.:	ZFX09000621		-	
ø 4,5 mm	DE-XI-SCTI-3.4-6.5	24 Ncm	-	
Art-Nr.:	ZFX09000621		-	
ø 5,5 mm	DE-XI-SCTI-3.4-6.5	24 Ncm	-	
Art-Nr.:	ZFX09000621		-	
ø 6,5 mm	DE-XI-SCTI-3.4-6.5	24 Ncm	-	
Art-Nr.:	ZFX09000621		-	

Schraubendreher



Standard-Schraube**Sechsrund-Schraube****Scanbodies**

ø 3,0 mm	AORAKI	-	FUJI
ø 3,4 mm	AORAKI	-	FUJI
ø 3,8 mm	AORAKI	-	FUJI
ø 4,5 mm	AORAKI	-	FUJI
ø 5,5 mm	AORAKI	-	FUJI
ø 6,5 mm	AORAKI	-	FUJI

Bestellinformationen zu Schraubendrehern ab Seite 8

DE-MU Type für das Dentsply Implants Multi-Purpose® Abutmentsystem

Scan-Bodies

		Desktop Scanbody <i>inkl. Standard-Schraube</i>	IOS Scanbody H4 <i>inkl. Standard-Schraube</i>	IOS Scanbody H7
				
		IM DOPPELPAK	IM DOPPELPAK	
3,4–3,8 mm		EVO-DE-MU-MACH-3.4-3.8	INTRA-DE-MU-MACH-3.4-3.8-H4	–
Art-Nr.:		ZFX05002165	ZFX05001931	–
4,5 mm		EVO-DE-MU-MACH-4.5	INTRA-DE-MU-MACH-4.5-H4	–
Art-Nr.:		ZFX05002166	ZFX05001932	–
5,5 mm		EVO-DE-MU-MACH-5.5	INTRA-DE-MU-MACH-5.5-H4	–
Art-Nr.:		ZFX05002167	ZFX05001933	–

Einzelkronen-Versorgung

Titanbasis rotationsgeschützt für Einzelkronen

Brücken-Versorgung

Titanbasis nicht rotationsgeschützt für Brücken

Small Design, inkl. Standard-Schraube



3,4–3,8 mm	–	S-TI-Base-DE-MU-TBUL-3.4-3.8
Art-Nr.:	–	ZFX11002093
4,5 mm	–	S-TI-Base-DE-MU-TBUL-4.5
Art-Nr.:	–	ZFX11002094
5,5 mm	–	S-TI-Base-DE-MU-TBUL-5.5
Art-Nr.:	–	ZFX11002095

*max. möglicher Schraubenkanal-Winkel

Komponenten-Zubehör

Pre-Abutment Blank**Ersatzschraube**
Standard-Schraube**Modellanalog**

IM DOPPELPAK

 \vec{M}
Drehmoment

3,4–3,8 mm	–	DE-MU-SCTI-3.4-5.5	24 Ncm	MC-Analog-DE-MU-3.4-3.8
Art-Nr.:	–	ZFX09001010		ZFX15002297
4,5 mm	–	DE-MU-SCTI-3.4-5.5	24 Ncm	MC-Analog-DE-MU-4.5
Art-Nr.:	–	ZFX09001010		ZFX15002298
5,5 mm	–	DE-MU-SCTI-3.4-5.5	24 Ncm	MC-Analog-DE-MU-5.5
Art-Nr.:	–	ZFX09001010		ZFX15002299

Komponenten-Zubehör für direkt-verschraubte Prothetik

Standard-Schraube**Sechsrund-Schraube**

≤ 20°*

 \vec{M}
Drehmoment

3,4–3,8 mm	DE-MU-SCTI-3.4-5.5	24 Ncm	–	
Art-Nr.:	ZFX09001010		–	
4,5 mm	DE-MU-SCTI-3.4-5.5	24 Ncm	–	
Art-Nr.:	ZFX09001010		–	
5,5 mm	DE-MU-SCTI-3.4-5.5	24 Ncm	–	
Art-Nr.:	ZFX09001010		–	

Schraubendreher



Standard-Schraube**Sechsrund-Schraube****Scanbodies**

3,4–3,8 mm	AORAKI	–	FUJI
4,5 mm	AORAKI	–	FUJI
5,5 mm	AORAKI	–	FUJI

Bestellinformationen zu Schraubendrehern ab Seite 8





AS-OS Type für das Dentsply Implants Osseospeed® Implantatsystem

Scan-Bodies

		Desktop Scanbody <i>inkl. Standard-Schraube</i>	IOS Scanbody H4 <i>inkl. Standard-Schraube</i>	IOS Scanbody H7 <i>inkl. Standard-Schraube</i>
				
		IM DOPPELPAK	IM DOPPELPAK	IM DOPPELPAK
ø 3,0 mm		EVO-AS-OS-MACH-3.0	INTRA-AS-OS-MACH-3.0-H4	INTRA-AS-OS-MACH-3.0-H7
Art-Nr.:		ZFX05002026	ZFX05001958	ZFX05001959
ø 3,5 / 4,0 mm		EVO-AS-OS-MACH-3.5-4.0	INTRA-AS-OS-MACH-3.5-4.0-H4	INTRA-AS-OS-MACH-3.5-4.0-H7
Art-Nr.:		ZFX05002027	ZFX05001960	ZFX05001961
ø 4,5 / 5,0 mm		EVO-AS-OS-MACH-4.5-5.0	INTRA-AS-OS-MACH-4.5-5.0-H4	INTRA-AS-OS-MACH-4.5-5.0-H7
Art-Nr.:		ZFX05002028	ZFX05001962	ZFX05001963

Einzelkronen-Versorgung

Brücken-Versorgung

		Titanbasis rotationsgeschützt für Einzelkronen <i>Regular Design, inkl. Standard-Schraube Small Design, inkl. Standard-Schraube</i>		Titanbasis nicht rotationsgeschützt für Brücken <i>Regular Design, inkl. Standard-Schraube Small Design, inkl. Standard-Schraube</i>	
					
ø 3,0 mm		–	S-TI-Base-AS-OS-TBLO-3.0	–	S-TI-Base-AS-OS-TBUL-3.0
Art-Nr.:		–	ZFX11000684	–	ZFX11000687
ø 3,5 / 4,0 mm		TI-Base-AS-OS-TBLO-3.5-4.0	S-TI-Base-AS-OS-TBLO-3.5-4.0	TI-Base-AS-OS-TBUL-3.5-4.0	S-TI-Base-AS-OS-TBUL-3.5-4.0
Art-Nr.:		ZFX11000685	ZFX11001113	ZFX11000688	ZFX11001116
ø 4,5 / 5,0 mm		TI-Base-AS-OS-TBLO-4.5-5.0	S-TI-Base-AS-OS-TBLO-4.5-5.0	TI-Base-AS-OS-TBUL-4.5-5.0	S-TI-Base-AS-OS-TBUL-4.5-5.0
Art-Nr.:		ZFX11000686	ZFX11001114	ZFX11000689	ZFX11001117

*max. möglicher Schraubenkanal-Winkel

Komponenten-Zubehör

Pre-Abutment Blank**Ersatzschraube**
Standard-Schraube**Modellanalog**

IM DOPPELPACK

 \vec{M}
Drehmoment

ø 3,0 mm	–	AS-OS-SCTI-3.0	15 Ncm	MC-Analog-AS-OS-3.0
Art-Nr.:	–	ZFX09000612		ZFX15002124
ø 3,5 / 4,0 mm	–	AS-OS-SCTI-3.5-4.0	20 Ncm	MC-Analog-AS-OS-3.5-4.0
Art-Nr.:	–	ZFX09000613		ZFX15002125
ø 4,5 / 5,0 mm	–	AS-OS-SCTI-4.5-5.0	25 Ncm	MC-Analog-AS-OS-3.5-4.0
Art-Nr.:	–	ZFX09000614		ZFX15002126

Komponenten-Zubehör für direkt-verschraubte Prothetik

Standard-Schraube**Sechsrund-Schraube**

≤ 20°*

 \vec{M}
Drehmoment

ø 3,0 mm	AS-OS-SCTI-3.0	15 Ncm	–	
Art-Nr.:	ZFX09000612		–	
ø 3,5 / 4,0 mm	AS-OS-SCTI-3.5-4.0	20 Ncm	–	
Art-Nr.:	ZFX09000613		–	
ø 4,5 / 5,0 mm	AS-OS-SCTI-4.5-5.0	25 Ncm	–	
Art-Nr.:	ZFX09000614		–	

Schraubendreher



Standard-Schraube**Sechsrund-Schraube****Scanbodies**

ø 3,0 mm	FUJI	–	FUJI
ø 3,5 / 4,0 mm	FUJI	–	FUJI
ø 4,5 / 5,0 mm	FUJI	–	FUJI

Bestellinformationen zu Schraubendrehern ab Seite 8

AS-UN Type für das Dentsply Implants (Astratech) UniAbutment® System

Scan-Bodies

		Desktop Scanbody <i>inkl. Standard-Schraube</i>	IOS Scanbody H4 <i>inkl. Standard-Schraube</i>	IOS Scanbody H7
				
		IM DOPPELPACK	IM DOPPELPACK	
20°		EVO-AS-UN-MACH-20°	INTRA-AS-UN-MACH-20°-H4	–
Art-Nr.:		ZFX05002163	ZFX05001929	–
45°		EVO-AS-UN-MACH-45°	INTRA-AS-UN-MACH-45°-H4	–
Art-Nr.:		ZFX05002164	ZFX05001930	–

Einzelkronen-Versorgung

Titanbasis rotationsgeschützt für Einzelkronen

Brücken-Versorgung

Titanbasis nicht rotationsgeschützt für Brücken

Small Design, inkl. Standard-Schraube



20°	–	S-TI-Base-AS-UN-TBUL-20°
Art-Nr.:	–	ZFX11002091
45°	–	S-TI-Base-AS-UN-TBUL-45°
Art-Nr.:	–	ZFX11002092

*max. möglicher Schraubenkanal-Winkel

Komponenten-Zubehör

Pre-Abutment Blank**Ersatzschraube**
Standard-Schraube**Modellanalog**

IM DOPPELPAK

 \vec{M}
Drehmoment

20°	–	AS-UN-SCTI-20°-45°	15 Ncm	MC-Analog-AS-UN-20°
Art-Nr.:	–	ZFX09001009		ZFX15002293
45°	–	AS-UN-SCTI-20°-45°	15 Ncm	MC-Analog-AS-UN-45°
Art-Nr.:	–	ZFX09001009		ZFX15002294

Komponenten-Zubehör für direkt-verschraubte Prothetik

Standard-Schraube**Sechsrund-Schraube**

≤ 20°*

 \vec{M}
Drehmoment

20°	AS-UN-SCTI-20°-45°	15 Ncm	–
Art-Nr.:	ZFX09001009		–
45°	AS-UN-SCTI-20°-45°	15 Ncm	–
Art-Nr.:	ZFX09001009		–

Schraubendreher

Standard-Schraube**Sechsrund-Schraube****Scanbodies**

20°	FUJI	–	FUJI
45°	FUJI	–	FUJI



Bestellinformationen zu Schraubendrehern ab Seite 8

GL-AN Type für das Global D. Angled conical® abutment System

Scan-Bodies

	Desktop Scanbody <i>inkl. Standard-Schraube</i>	IOS Scanbody H4	IOS Scanbody H7
	 IM DOPPELPAK		
ø 4,7 mm	EVO-GL-AN-MACH-4.7	–	–
Art-Nr.:	ZFX05002198	–	–

Schraubendreher

	Standard-Schraube	Sechsrund-Schraube 	Scanbodies
ø 4,7 mm	AORAKI	–	FUJI
 Bestellinformationen zu Schraubendrehern ab Seite 8			

GL-IK Type für das Global D. In-Kone® Implantatsystem

Scan-Bodies

	Desktop Scanbody <i>inkl. Standard-Schraube</i>	IOS Scanbody H4	IOS Scanbody H7
	 IM DOPPELPAK		
ø 3,5/5,0 mm	EVO-GL-IK-MACH-3.5-5.0	–	–
Art-Nr.:	ZFX05002209	–	–

Schraubendreher

	Standard-Schraube	Sechsrund-Schraube 	Scanbodies
ø 3,5/5,0 mm	AORAKI	–	FUJI
 Bestellinformationen zu Schraubendrehern ab Seite 8			

*max. möglicher Schraubenkanal-Winkel

GL-ST Type für das Global D. Straight conical® abutment System

Scan-Bodies

	Desktop Scanbody <i>inkl. Standard-Schraube</i>	IOS Scanbody H4	IOS Scanbody H7
	 IM DOPPELPAK		
ø 4,3 mm	EVO-GL-ST-MACH-4.3	–	–
Art-Nr.:	ZFX05002196	–	–

Schraubendreher



	Standard-Schraube	Sechsrund-Schraube 	Scanbodies
ø 4,3 mm	AORAKI	–	FUJI
 Bestellinformationen zu Schraubendrehern ab Seite 8			

GL-TK Type für das Global D. Twinkon® Implantatsystem

Scan-Bodies

	Desktop Scanbody <i>inkl. Standard-Schraube</i>	IOS Scanbody H4	IOS Scanbody H7
	 IM DOPPELPAK		
ø 4,0 / 4,5 mm	EVO-GL-TK-MACH-4.0-4.5	–	–
Art-Nr.:	ZFX05002210	–	–

Schraubendreher

	Standard-Schraube	Sechsrund-Schraube 	Scanbodies
ø 4,0 / 4,5 mm	AORAKI	–	FUJI
 Bestellinformationen zu Schraubendrehern ab Seite 8			

ME-ON Type für das Megagen AnyOne® Implantatsystem

Scan-Bodies

	Desktop Scanbody <i>inkl. Standard-Schraube</i>	IOS Scanbody H4 <i>inkl. Standard-Schraube</i>	IOS Scanbody H7
	 IM DOPPELPACK	 IM DOPPELPACK	
∅3,5/7,0mm	EVO-ME-ON-MACH-3.5-7.0	INTRA-ME-ON-MACH-3.5-7.0-H4	–
Art-Nr.:	ZFX05002202	ZFX05002310	–

Schraubendreher

	Standard-Schraube	Sechsrund-Schraube 	Scanbodies
∅3,5/7,0mm	AORAKI	–	FUJI
 Bestellinformationen zu Schraubendrehern ab Seite 8			

*max. möglicher Schraubenkanal-Winkel

ME-AN Type für das Megagen AnyRidge® Implantatsystem

Scan-Bodies

Desktop Scanbody

inkl. Standard-Schraube

IM DOPPELPAK



IOS Scanbody H4

inkl. Standard-Schraube

IM DOPPELPAK



IOS Scanbody H7

inkl. Standard-Schraube

IM DOPPELPAK



ø3,5/8,0mm	EVO-ME-AN-MACH-3.5-8.0	INTRA-ME-AN-MACH-3.5-8.0-H4	INTRA-ME-AN-MACH-3.5-8.0-H7
Art-Nr.:	ZFX05002269	ZFX05001922	ZFX05001923

Einzelkronen-Versorgung

Titanbasis rotationsgeschützt für Einzelkronen

Small Design, inkl. Standard-Schraube



Komponenten-Zubehör

Ersatzschraube

Standard-Schraube

 \vec{M}
Drehmoment

Modellanalog



IM DOPPELPAK

ø3,5/8,0mm	S-TI-Base-ME-AN-TBLO-3.5-8.0	ME-AN-SCTI-3.5-8.0	25 – 35 Ncm	MC-Analog-ME-AN-3.5-8.0
Art-Nr.:	ZFX11002213	ZFX09002258		ZFX15002326

Komponenten-Zubehör für direkt-verschraubte Prothetik

Standard-Schraube

Sechsrund-Schraube

0°

 \vec{M}
Drehmoment

ø3,5/8,0mm	ME-AN-SCTI-3.5-8.0	25–35 Ncm	–	
Art-Nr.:	ZFX09002258		–	

Schraubendreher

Standard-Schraube

Sechsrund-Schraube



Scanbodies

ø3,5/8,0mm	AORAKI	–	FUJI
-------------------	--------	---	------

Bestellinformationen zu Schraubendrehern ab Seite 8

ME-EZ Type für das Megagen EZ Plus® Implantatsystem

Scan-Bodies

Desktop Scanbody *inkl. Standard-Schraube*

IM DOPPELPAK



IOS Scanbody H4 *inkl. Standard-Schraube*

IM DOPPELPAK



IOS Scanbody H7 *inkl. Standard-Schraube*

IM DOPPELPAK



ø 3,3 mm	EVO-ME-EZ-MACH-3.3	INTRA-ME-EZ-MACH-3.3-H4	INTRA-ME-EZ-MACH-3.3-H7
Art-Nr.:	ZFX05002175	ZFX05001232	ZFX05001233
ø 4,0 / 5,0 mm	EVO-ME-EZ-MACH-4.0-5.0	INTRA-ME-EZ-MACH-4.0-5.0-H4	INTRA-ME-EZ-MACH-4.0-5.0-H7
Art-Nr.:	ZFX05002176	ZFX05001234	ZFX05001235

Einzelkronen-Versorgung

Titanbasis rotationsgeschützt für Einzelkronen *Small Design, inkl. Standard-Schraube*



Brücken-Versorgung

Titanbasis nicht rotationsgeschützt für Brücken *Small Design, inkl. Standard-Schraube*



ø 3,3 mm	S-TI-Base-ME-EZ-TBLO-3.3	S-TI-Base-ME-EZ-TBUL-3.3
Art-Nr.:	ZFX11002188	ZFX11002191
ø 4,0 / 5,0 mm	S-TI-Base-ME-EZ-TBLO-4.0-5.0	S-TI-Base-ME-EZ-TBUL-4.0-5.0
Art-Nr.:	ZFX11002189	ZFX11002192

*max. möglicher Schraubenkanal-Winkel

Komponenten-Zubehör

Pre-Abutment Blank**Ersatzschraube**
Standard-Schraube**Modellanalog**

IM DOPPELPAK



ø 3,3 mm	–	ME-EZ-SCTI-3.3	25–35 Ncm	MC-Analog-ME-EZ-3.3
Art-Nr.:	–	ZFX09002182		ZFX15002323
ø 4,0 / 5,0 mm	–	ME-EZ-SCTI-4.0-5.0	25–35 Ncm	MC-Analog-ME-EZ-4.0-5.0
Art-Nr.:	–	ZFX09002183		ZFX15002324

Komponenten-Zubehör für direkt-verschraubte Prothetik

Standard-Schraube**Sechsrund-Schraube**

≤20°*

 \vec{M}
Drehmoment

ø 3,3 mm	ME-EZ-SCTI-3.3	25–35 Ncm	–	
Art-Nr.:	ZFX09002182		–	
ø 4,0 / 5,0 mm	ME-EZ-SCTI-4.0-5.0	25–35 Ncm	–	
Art-Nr.:	ZFX09002183		–	

Schraubendreher

Standard-Schraube**Sechsrund-Schraube****Scanbodies**

ø 3,3 mm	AORAKI	–	FUJI
ø 4,0 / 5,0 mm	AORAKI	–	FUJI

Bestellinformationen zu Schraubendrehern ab Seite 8

ME-MUA Type für das Megagen Multi-Unit Abutment® System

Scan-Bodies

	Desktop Scanbody <i>inkl. Standard-Schraube</i>	IOS Scanbody H4 <i>inkl. Standard-Schraube</i>	IOS Scanbody H7
	 IM DOPPELPACK	 IM DOPPELPACK	
∅4,8mm	EVO-ME-MUA-4.8	INTRA-ME-MUA-MACH-4.8-H4	–
Art-Nr.:	ZFX05D-ME-MUA-48	ZFX05I-ME-MUA-48-H4	–

Schraubendreher

	Standard-Schraube	Sechsrund-Schraube 	Scanbodies
∅4,8mm	AORAKI	–	FUJI
 Bestellinformationen zu Schraubendrehern ab Seite 8			

*max. möglicher Schraubenkanal-Winkel



ME-RE Type für das Megagen Rescue Internal® Implantatsystem

Scan-Bodies

	Desktop Scanbody <i>inkl. Standard-Schraube</i>	IOS Scanbody H4 <i>inkl. Standard-Schraube</i>	IOS Scanbody H7 <i>inkl. Standard-Schraube</i>
	 IM DOPPELPAK	 IM DOPPELPAK	 IM DOPPELPAK
∅ 4,5 / 6,0 mm	EVO-ME-RE-MACH-4.5-6.0	INTRA-ME-RE-MACH-4.5-6.0-H4	INTRA-ME-RE-MACH-4.5-6.0-H7
Art-Nr.:	ZFX05002177	ZFX05001100	ZFX05001101

Einzelkronen-Versorgung

	Titanbasis rotationsgeschützt für Einzelkronen <i>Small Design, inkl. Standard-Schraube</i>
	
∅ 4,5 / 6,0 mm	S-TI-Base-ME-RE-TBLO-4.5-6.0
Art-Nr.:	ZFX11002190

Brücken-Versorgung

	Titanbasis nicht rotationsgeschützt für Brücken <i>Small Design, inkl. Standard-Schraube</i>
	
∅ 4,5 / 6,0 mm	S-TI-Base-ME-RE-TBUL-4.5-6.0
Art-Nr.:	ZFX11002193

* max. möglicher Schraubenkanal-Winkel

Komponenten-Zubehör

Pre-Abutment Blank

Ersatzschraube Standard-Schraube

Modellanalog

IM DOPPELPAK



\vec{M}
Drehmoment



ø4,5/6,0mm	-	ME-RE-SCTI-4.5-6.0	25 – 35 Ncm	MC-Analog-ME-RE-4.5-6.0
Art-Nr.:	-	ZFX09002184		ZFX15002325

Komponenten-Zubehör für direkt-verschraubte Prothetik

Standard-Schraube

Sechsrund-Schraube

≤20°*



\vec{M}
Drehmoment



ø4,5/6,0mm	ME-RE-SCTI-4.5-6.0	25 – 35 Ncm	-	
Art-Nr.:	ZFX09002184		-	

Schraubendreher

Standard-Schraube

Sechsrund-Schraube





Scanbodies

ø4,5/6,0mm	AORAKI	-	FUJI
-------------------	--------	---	------

Bestellinformationen zu Schraubendrehern ab Seite 8

MC-TR Type für das Microdent Trylogic® Implantatsystem

Scan-Bodies

	Desktop Scanbody <i>inkl. Standard-Schraube</i>	IOS Scanbody H4 <i>inkl. Standard-Schraube</i>	IOS Scanbody H7 <i>inkl. Standard-Schraube</i>
	 IM DOPPELPACK	 IM DOPPELPACK	 IM DOPPELPACK
ø 3,8 mm	EVO-MC-TR-MACH-3.8	INTRA-MC-TR-MACH-3.8-H4	INTRA-MC-TR-MACH-3.8-H7
Art-Nr.:	ZFX05002257	ZFX05001134	ZFX05001135
ø 4,3 mm	EVO-MC-TR-MACH-4.3	INTRA-MC-TR-MACH-4.3-H4	INTRA-MC-TR-MACH-4.3-H7
Art-Nr.:	ZFX05002258	ZFX05001136	ZFX05001137
ø 5,1 mm	EVO-MC-TR-MACH-5.1	INTRA-MC-TR-MACH-5.1-H4	INTRA-MC-TR-MACH-5.1-H7
Art-Nr.:	ZFX05002259	ZFX05001138	ZFX05001139
ø 5,6 mm	EVO-MC-TR-MACH-5.6	INTRA-MC-TR-MACH-5.6-H4	INTRA-MC-TR-MACH-5.6-H7
Art-Nr.:	ZFX05002260	ZFX05001140	ZFX05001141



Schraubendreher

	Standard-Schraube	Sechsrund-Schraube 	Scanbodies
ø 3,8 mm	MERU	–	FUJI
ø 4,3 mm	MERU	–	FUJI
ø 5,1 mm	MERU	–	FUJI
ø 5,6 mm	MERU	–	FUJI

 Bestellinformationen zu Schraubendrehern ab Seite 8

MI-IN Type für das MIS Internal Hex® Implantatsystem

Scan-Bodies

	Desktop Scanbody <i>inkl. Standard-Schraube</i>	IOS Scanbody H4 <i>inkl. Standard-Schraube</i>	IOS Scanbody H7 <i>inkl. Standard-Schraube</i>
	 IM DOPPELPACK	 IM DOPPELPACK	 IM DOPPELPACK
ø 3,3 mm	EVO-MI-IN-MACH-3.3	–	–
Art-Nr.:	ZFX05002204	–	–
ø 3,75/4,2 mm	EVO-MI-IN-MACH-3.75-4.2	INTRA-MI-IN-MACH-3.75-4.2-H4	INTRA-MI-IN-MACH-3.75-4.2-H7
Art-Nr.:	ZFX05002291	ZFX05002293	ZFX05002295
ø 5,0/6,0 mm	EVO-MI-IN-MACH-5.0-6.0	INTRA-MI-IN-MACH-5.0-6.0-H4	INTRA-MI-IN-MACH-5.0-6.0-H7
Art-Nr.:	ZFX05002292	ZFX05002294	ZFX05002296

Komponenten-Zubehör

	Pre-Abutment Blank	Ersatzschraube	Modellanalog
			 IM DOPPELPACK
ø 3,3 mm	–	–	–
Art-Nr.:	–	–	–
ø 3,75/4,2 mm	–	–	MC-Analog-MI-IN-3.75-4.2
Art-Nr.:	–	–	ZFX15002334
ø 5,0/6,0 mm	–	–	MC-Analog-MI-IN-5.0-6.0
Art-Nr.:	–	–	ZFX15002335

Schraubendreher

	Standard-Schraube	Sechsrund-Schraube 	Scanbodies
ø 3,3 mm	FUJI	–	FUJI
ø 3,75/4,2 mm	FUJI	–	FUJI
ø 5,0/6,0 mm	FUJI	–	FUJI



 Bestellinformationen zu Schraubendrehern ab Seite 8

MI-MU Type für das MIS Multi-Unit® Abutmentsystem

Scan-Bodies

	Desktop Scanbody <i>inkl. Standard-Schraube</i>	IOS Scanbody H4	IOS Scanbody H7
	 <p>IM DOPPELPAK</p>		
∅ 4,8 mm	EVO-MI-MU-MACH-4.8	–	–
Art-Nr.:	ZFX05002213	–	–

Schraubendreher



	Standard-Schraube	Sechsrund-Schraube 	Scanbodies
∅ 4,8 mm	FUJI	–	FUJI
 Bestellinformationen zu Schraubendrehern ab Seite 8			

*max. möglicher Schraubenkanal-Winkel







NO-AC Type für das Nobel Biocare Active® Implantatsystem

Scan-Bodies

		Desktop Scanbody <i>inkl. Standard-Schraube</i>	IOS Scanbody H4 <i>inkl. Standard-Schraube</i>	IOS Scanbody H7 <i>inkl. Standard-Schraube</i>
				
		IM DOPPELPAK	IM DOPPELPAK	IM DOPPELPAK
ø 3,0 mm		EVO-NO-AC-MACH-3.0	–	–
Art-Nr.:		ZFX05002182	–	–
ø 3,5 mm		EVO-NO-AC-MACH-3.5	INTRA-NO-AC-MACH-3.5-H4	INTRA-NO-AC-MACH-3.5-H7
Art-Nr.:		ZFX05002040	ZFX05001986	ZFX05001987
ø 4,3 / 5,0 mm		EVO-NO-AC-MACH-4.3-5.0	INTRA-NO-AC-MACH-4.3-5.0-H4	INTRA-NO-AC-MACH-4.3-5.0-H7
Art-Nr.:		ZFX05002041	ZFX05001988	ZFX05001989
ø 5,5 mm		EVO-NO-AC-MACH-5.5	–	–
Art-Nr.:		ZFX05002183	–	–

Einzelkronen-Versorgung

Brücken-Versorgung

		Titanbasis rotationsgeschützt für Einzelkronen <i>Regular Design, inkl. Standard-Schraube Small Design, inkl. Standard-Schraube</i>		Titanbasis nicht rotationsgeschützt für Brücken <i>Regular Design, inkl. Standard-Schraube Small Design, inkl. Standard-Schraube</i>	
					
ø 3,0 mm		–	–	–	–
Art-Nr.:		–	–	–	–
ø 3,5 mm		TI-Base-NO-AC-TBLO-3.5	S-TI-Base-NO-AC-TBLO-3.5	TI-Base-NO-AC-TBUL-3.5	S-TI-Base-NO-AC-TBUL-3.5
Art-Nr.:		ZFX11000713	ZFX11001130	ZFX11000715	ZFX11001132
ø 4,3 / 5,0 mm		TI-Base-NO-AC-TBLO-4.3-5.0	S-TI-Base-NO-AC-TBLO-4.3-5.0	TI-Base-NO-AC-TBUL-4.3-5.0	S-TI-Base-NO-AC-TBUL-4.3-5.0
Art-Nr.:		ZFX11000714	ZFX11001131	ZFX11000716	ZFX11001133
ø 5,5 mm		–	–	–	–
Art-Nr.:		–	–	–	–

*max. möglicher Schraubenkanal-Winkel

Komponenten-Zubehör

Pre-Abutment Blank
inkl. Standard-Schraube**Ersatzschraube**
Standard-Schraube
 \vec{M}
Drehmoment
Modellanalog

IM DOPPELPAK

ø 3,0 mm	–	–	–	–
Art-Nr.:	–	–	–	–
ø 3,5 mm	Pre-Abutment Blank	NO-AC-SCTI-3.5	35 Ncm	MC-Analog-NO-AC-3.5
Art-Nr.:	ZFX18000210	ZFX09000627		ZFX15002138
ø 4,3/5,0 mm	Pre-Abutment Blank	NO-AC-SCTI-4.3-5.0	35 Ncm	MC-Analog-NO-AC-4.3-5.0
Art-Nr.:	ZFX18000220	ZFX09000628		ZFX15002139
ø 5,5 mm	–	NO-AC-SCTI-4.3-5.0	35 Ncm	–
Art-Nr.:	–	ZFX09000628		–

Komponenten-Zubehör für direkt-verschraubte Prothetik

Standard-Schraube**Sechsrund-Schraube**

≤ 25°*

 \vec{M}
Drehmoment

ø 3,0 mm	–	–	–
Art-Nr.:	–	–	–
ø 3,5 mm	NO-AC-SCTI-3.5	35 Ncm	–
Art-Nr.:	ZFX09000627		–
ø 4,3/5,0 mm	NO-AC-SCTI-4.3-5.0	35 Ncm	–
Art-Nr.:	ZFX09000628		–
ø 5,5 mm	NO-AC-SCTI-4.3-5.0	35 Ncm	–
Art-Nr.:	ZFX09000628		–

Schraubendreher



Standard-Schraube**Sechsrund-Schraube****Scanbodies**

ø 3,0 mm	AORAKI	–	FUJI
ø 3,5 mm	AORAKI	–	FUJI
ø 4,3/5,0 mm	AORAKI	–	FUJI
ø 5,5 mm	AORAKI	–	FUJI

Bestellinformationen zu Schraubendrehern ab Seite 8





NO-BR Type für das Nobel Biocare Brånemark® Implantatsystem

Scan-Bodies

	Desktop Scanbody <i>inkl. Standard-Schraube</i>	IOS Scanbody H4 <i>inkl. Standard-Schraube</i>	IOS Scanbody H7 <i>inkl. Standard-Schraube</i>
	 IM DOPPELPAK	 IM DOPPELPAK	 IM DOPPELPAK
ø 3,5 mm	EVO-NO-BR-MACH-3.5	INTRA-NO-BR-MACH-3.5-H4	INTRA-NO-BR-MACH-3.5-H7
Art-Nr.:	ZFX05002042	ZFX05001990	ZFX05001991
ø 4,1 mm	EVO-NO-BR-MACH-4.1	INTRA-NO-BR-MACH-4.1-H4	INTRA-NO-BR-MACH-4.1-H7
Art-Nr.:	ZFX05002043	ZFX05001992	ZFX05001993
ø 5,1 mm	EVO-NO-BR-MACH-5.1	INTRA-NO-BR-MACH-5.1-H4	INTRA-NO-BR-MACH-5.1-H7
Art-Nr.:	ZFX05002044	ZFX05001994	ZFX05001995

Einzelkronen-Versorgung

Brücken-Versorgung

	Titanbasis rotationsgeschützt für Einzelkronen <i>Regular Design, inkl. Standard-Schraube Small Design, inkl. Standard-Schraube</i>		Titanbasis nicht rotationsgeschützt für Brücken <i>Regular Design, inkl. Standard-Schraube Small Design, inkl. Standard-Schraube</i>	
				
ø 3,5 mm	TI-Base-NO-BR-TBLO-3.5	S-TI-Base-NO-BR-TBLO-3.5	–	S-TI-Base-NO-BR-TBUL-3.5
Art-Nr.:	ZFX11000717	ZFX11001134	–	ZFX11000720
ø 4,1 mm	TI-Base-NO-BR-TBLO-4.1	S-TI-Base-NO-BR-TBLO-4.1	–	S-TI-Base-NO-BR-TBUL-4.1
Art-Nr.:	ZFX11000718	ZFX11001135	–	ZFX11000721
ø 5,1 mm	TI-Base-NO-BR-TBLO-5.1	S-TI-Base-NO-BR-TBLO-5.1	–	S-TI-Base-NO-BR-TBUL-5.1
Art-Nr.:	ZFX11000719	ZFX11001136	–	ZFX11000722

*max. möglicher Schraubenkanal-Winkel

Komponenten-Zubehör

Pre-Abutment Blank
inkl. Standard-Schraube**Ersatzschraube**
Standard-Schraube**Modellanalog**

IM DOPPELPAK

ø 3,5 mm	Pre-Abutment Blank	NO-BR-SCTI-3.5	35Ncm	MC-Analog-NO-BR-3.5
Art-Nr.:	ZFX18000230	ZFX09000631		ZFX15002140
ø 4,1 mm	Pre-Abutment Blank	NO-BR-SCTI-4.1	35 Ncm	MC-Analog-NO-BR-4.1
Art-Nr.:	ZFX18000240	ZFX09000632		ZFX15002141
ø 5,1 mm	Pre-Abutment Blank	NO-BR-SCTI-5.1	35 Ncm	MC-Analog-NO-BR-5.1
Art-Nr.:	ZFX18000250	ZFX09000633		ZFX15002142

Komponenten-Zubehör für direkt-verschraubte Prothetik

Standard-Schraube**Sechsrund-Schraube**

≤ 20°*



ø 3,5 mm	NO-BR-SCTI-3.5	35 Ncm	–
Art-Nr.:	ZFX09000631		–
ø 4,1 mm	NO-BR-SCTI-4.1	35 Ncm	–
Art-Nr.:	ZFX09000632		–
ø 5,1 mm	NO-BR-SCTI-5.1	35 Ncm	–
Art-Nr.:	ZFX09000633		–

Schraubendreher



Standard-Schraube**Sechsrund-Schraube****Scanbodies**

ø 3,5 mm	AORAKI	–	FUJI
ø 4,1 mm	AORAKI	–	FUJI
ø 5,1 mm	AORAKI	–	FUJI

Bestellinformationen zu Schraubendrehern ab Seite 8

NO-MU Type für das Nobel Biocare Multi-unit® Abutmentsystem

Scan-Bodies

		Desktop Scanbody <i>inkl. Standard-Schraube</i>	IOS Scanbody H4 <i>inkl. Standard-Schraube</i>	IOS Scanbody H7 <i>inkl. Standard-Schraube</i>
				
		IM DOPPELPAK	IM DOPPELPAK	IM DOPPELPAK
ø 4,8 mm		EVO-NO-MU-MACH-4.8	INTRA-NO-MU-MACH-4.8-H4	INTRA-NO-MU-MACH-4.8-H7
Art-Nr.:		ZFX05002045	ZFX05001228	ZFX05001229
ø 6,0 mm		EVO-NO-MU-MACH-6.0	INTRA-NO-MU-MACH-6.0-H4	INTRA-NO-MU-MACH-6.0-H7
Art-Nr.:		ZFX05002046	ZFX05001230	ZFX05001231

Einzelkronen-Versorgung

Titanbasis rotationsgeschützt für Einzelkronen

Brücken-Versorgung

Titanbasis nicht rotationsgeschützt für Brücken

Small Design, inkl. Standard-Schraube

			
ø 4,8 mm		–	TI-Base-NO-MU-TBUL-4.8
Art-Nr.:		–	ZFX11000723
ø 6,0 mm		–	TI-Base-NO-MU-TBUL-6.0
Art-Nr.:		–	ZFX11000724

*max. möglicher Schraubenkanal-Winkel

Komponenten-Zubehör

Pre-Abutment Blank**Ersatzschraube**
Standard-Schraube**Modellanalog**

IM DOPPELPACK

 \vec{M}
Drehmoment

ø 4,8 mm	–	NO-MU-SCTI-4.8	15 Ncm	MC-Analog-NO-MU-4.8
Art-Nr.:	–	ZFX09000637		ZFX15002300
ø 6,0 mm	–	NO-MU-SCTI-6.0	15 Ncm	MC-Analog-NO-MU-6.0
Art-Nr.:	–	ZFX09000638		ZFX15002301

Komponenten-Zubehör für direkt-verschraubte Prothetik

Standard-Schraube**Sechsrund-Schraube**

≤ 20°*

 \vec{M}
Drehmoment

ø 4,8 mm	NO-MU-SCTI-4.8	15 Ncm	–	
Art-Nr.:	ZFX09000637		–	
ø 6,0 mm	NO-MU-SCTI-6.0	15 Ncm	–	
Art-Nr.:	ZFX09000638		–	

Schraubendreher



Standard-Schraube**Sechsrund-Schraube****Scanbodies**

ø 4,8 mm	AORAKI	–	FUJI
ø 6,0 mm	AORAKI	–	FUJI

Bestellinformationen zu Schraubendrehern ab Seite 8

NO-RE Type für das Nobel Biocare Replace® Implantatsystem

Scan-Bodies

		Desktop Scanbody <i>inkl. Standard-Schraube</i>	IOS Scanbody H4 <i>inkl. Standard-Schraube</i>	IOS Scanbody H7 <i>inkl. Standard-Schraube</i>
				
		IM DOPPELPAK	IM DOPPELPAK	IM DOPPELPAK
ø 3,5 mm		EVO-NO-RE-MACH-3.5	INTRA-NO-RE-MACH-3.5-H4	INTRA-NO-RE-MACH-3.5-H7
Art-Nr.:		ZFX05002047	ZFX05001996	ZFX05001997
ø 4,3 mm		EVO-NO-RE-MACH-4.3	INTRA-NO-RE-MACH-4.3-H4	INTRA-NO-RE-MACH-4.3-H7
Art-Nr.:		ZFX05002048	ZFX05001998	ZFX05001999
ø 5,0 mm		EVO-NO-RE-MACH-5.0	INTRA-NO-RE-MACH-5.0-H4	INTRA-NO-RE-MACH-5.0-H7
Art-Nr.:		ZFX05002049	ZFX05002000	ZFX05002001
ø 6,0 mm		EVO-NO-RE-MACH-6.0	INTRA-NO-RE-MACH-6.0-H4	INTRA-NO-RE-MACH-6.0-H7
Art-Nr.:		ZFX05002050	ZFX05002002	ZFX05002003

Einzelkronen-Versorgung

Brücken-Versorgung

		Titanbasis rotationsgeschützt für Einzelkronen <i>Regular Design, inkl. Standard-Schraube Small Design, inkl. Standard-Schraube</i>		Titanbasis nicht rotationsgeschützt für Brücken <i>Regular Design, inkl. Standard-Schraube Small Design, inkl. Standard-Schraube</i>	
					
ø 3,5 mm		TI-Base-NO-RE-TBLO-3.5	S-TI-Base-NO-RE-TBLO-3.5	TI-Base-NO-RE-TBUL-3.5	S-TI-Base-NO-RE-TBUL-3.5
Art-Nr.:		ZFX11000725	ZFX11001140	ZFX11000729	ZFX11001144
ø 4,3 mm		TI-Base-NO-RE-TBLO-4.3	S-TI-Base-NO-RE-TBLO-4.3	TI-Base-NO-RE-TBUL-4.3	S-TI-Base-NO-RE-TBUL-4.3
Art-Nr.:		ZFX11000726	ZFX11001141	ZFX11000730	ZFX11001145
ø 5,0 mm		TI-Base-NO-RE-TBLO-5.0	S-TI-Base-NO-RE-TBLO-5.0	TI-Base-NO-RE-TBUL-5.0	S-TI-Base-NO-RE-TBUL-5.0
Art-Nr.:		ZFX11000727	ZFX11001142	ZFX11000731	ZFX11001146
ø 6,0 mm		TI-Base-NO-RE-TBLO-6.0	S-TI-Base-NO-RE-TBLO-6.0	TI-Base-NO-RE-TBUL-6.0	S-TI-Base-NO-RE-TBUL-6.0
Art-Nr.:		ZFX11000728	ZFX11001143	ZFX11000732	ZFX11001147

*max. möglicher Schraubenkanal-Winkel

Komponenten-Zubehör

Pre-Abutment Blank
inkl. Standard-Schraube**Ersatzschraube**
Standard-Schraube**Modellanalog**

ø 3,5 mm	Pre-Abutment Blank	NO-RE-SCTI-3.5	35 Ncm	MC-Analog-NO-RE-3.5
Art-Nr.:	ZFX18000170	ZFX09000641		ZFX15002143
ø 4,3 mm	Pre-Abutment Blank	NO-RE-SCTI-4.3-6.0	35 Ncm	MC-Analog-NO-RE-4.3
Art-Nr.:	ZFX18000180	ZFX09000642		ZFX15002144
ø 5,0 mm	Pre-Abutment Blank	NO-RE-SCTI-4.3-6.0	35 Ncm	MC-Analog-NO-RE-5.0
Art-Nr.:	ZFX18000190	ZFX09000642		ZFX15002145
ø 6,0 mm	Pre-Abutment Blank	NO-RE-SCTI-4.3-6.0	35 Ncm	MC-Analog-NO-RE-6.0
Art-Nr.:	ZFX18000200	ZFX09000642		ZFX15002146

Komponenten-Zubehör für direkt-verschraubte Prothetik

Standard-Schraube**Sechsrund-Schraube**

≤ 20°*



ø 3,5 mm	NO-RE-SCTI-3.5	35 Ncm	–	
Art-Nr.:	ZFX09000641		–	
ø 4,3 mm	NO-RE-SCTI-4.3-6.0	35 Ncm	–	
Art-Nr.:	ZFX09000642		–	
ø 5,0 mm	NO-RE-SCTI-4.3-6.0	35 Ncm	–	
Art-Nr.:	ZFX09000642		–	
ø 6,0 mm	NO-RE-SCTI-4.3-6.0	35 Ncm	–	
Art-Nr.:	ZFX09000642		–	

Schraubendreher



Standard-Schraube**Sechsrund-Schraube****Scanbodies**

ø 3,5 mm	AORAKI	–	FUJI
ø 4,3 mm	AORAKI	–	FUJI
ø 5,0 mm	AORAKI	–	FUJI
ø 6,0 mm	AORAKI	–	FUJI

 Bestellinformationen zu Schraubendrehern ab Seite 8



OS-GS Type für das Osstem GS & TS System® Implantatsystem

Scan-Bodies

		Desktop Scanbody <i>inkl. Standard-Schraube</i>	IOS Scanbody H4 <i>inkl. Standard-Schraube</i>	IOS Scanbody H7 <i>inkl. Standard-Schraube</i>
				
		IM DOPPELPACK	IM DOPPELPACK	IM DOPPELPACK
ø 3,5mm		EVO-OS-GS-MACH-3.5	INTRA-OS-GS-MACH-3.5-H	INTRA-OS-GS-MACH-3.5-H7
Art-Nr.:		ZFX05002173	ZFX05001096	ZFX05001097
ø 4,0/7,0mm		EVO-OS-GS-MACH-4.0-7.0	INTRA-OS-GS-MACH-4.0-7.0-H4	INTRA-OS-GS-MACH-4.0-7.0-H7
Art-Nr.:		ZFX05002174	ZFX05001098	ZFX05001099

Einzelkronen-Versorgung

Brücken-Versorgung

		Titanbasis rotationsgeschützt für Einzelkronen	Titanbasis nicht rotationsgeschützt für Brücken <i>Small Design, inkl. Standard-Schraube</i>
			
ø 3,5mm		S-TI-Base-OS-GS-TBLO-3.5	S-TI-Base-OS-GS-TBUL-3.5
Art-Nr.:		ZFX11002112	ZFX11002114
ø 4,0/7,0mm		S-TI-Base-OS-GS-TBLO-4.0-7.0	S-TI-Base-OS-GS-TBUL-4.0-7.0
Art-Nr.:		ZFX11002113	ZFX11002115

*max. möglicher Schraubenkanal-Winkel

Komponenten-Zubehör

Pre-Abutment Blank**Ersatzschraube**
Standard-Schraube**Modellanalog**

IM DOPPELPACK

 \vec{M}
Drehmoment

ø 3,5mm	–	OS-GS-SCTI-3.5	20 Ncm	MC-Analog-OS-GS-3.5
Art-Nr.:	–	ZFX09002110		ZFX15002308
ø 4,0/7,0mm	–	OS-GS-SCTI-4.0-7.0	30 Ncm	MC-Analog-OS-GS-4.0-7.0
Art-Nr.:	–	ZFX09002111		ZFX15002309

Komponenten-Zubehör für direkt-verschraubte Prothetik

Standard-Schraube**Sechsrund-Schraube**

≤ 20°*

 \vec{M}
Drehmoment

ø 3,5mm	OS-GS-SCTI-3.5	20 Ncm	–
Art-Nr.:	ZFX09002110		–
ø 4,0/7,0mm	OS-GS-SCTI-4.0-7.0	30 Ncm	–
Art-Nr.:	ZFX09002111		–

Schraubendreher



Standard-Schraube**Sechsrund-Schraube****Scanbodies**

ø 3,5mm	AORAKI	–	FUJI
ø 4,0/7,0mm	AORAKI	–	FUJI

Bestellinformationen zu Schraubendrehern ab Seite 8

PI-AMP Type für das P-I Amplified® Implantatsystem

Scan-Bodies

	Desktop Scanbody <i>inkl. Standard-Schraube</i>	IOS Scanbody H4 <i>inkl. Standard-Schraube</i>	IOS Scanbody H7 <i>inkl. Standard-Schraube</i>
	 IM DOPPELPACK	 IM DOPPELPACK	 IM DOPPELPACK
ø 3,5mm	EVO-PI-AMP-MACH-3.5	INTRA-PI-AMP-MACH-3.5-H4	INTRA-PI-AMP-MACH-3.5-H7
Art-Nr.:	ZFX05002273	ZFX05002297	ZFX05002299
ø 4,3/5,1mm	EVO-PI-AMP-MACH-4.3-5.1	INTRA-PI-AMP-MACH-4.3-5.1-H4	INTRA-PI-AMP-MACH-4.3-5.1-H7
Art-Nr.:	ZFX05002274	ZFX05002298	ZFX05002300

Komponenten-Zubehör

	Pre-Abutment Blank	Ersatzschraube	Modellanalog
			 IM DOPPELPACK
ø 3,5mm	–	–	MC-Analog-PI-AMP-3.5
Art-Nr.:	–	–	ZFX15002336
ø 4,3/5,1mm	–	–	MC-Analog-PI-AMP-4.3-5.1
Art-Nr.:	–	–	ZFX15002337

Schraubendreher

	Standard-Schraube	Sechsrund-Schraube 	Scanbodies
ø 3,5mm	AORAKI	–	FUJI
ø 4,3/5,1mm	AORAKI	–	FUJI

 Bestellinformationen zu Schraubendrehern ab Seite 8



*max. möglicher Schraubenkanal-Winkel

PI-CO Type für das P-I Conical Abutment® Implantatsystem

Scan-Bodies



	Desktop Scanbody <i>inkl. Standard-Schraube</i>	IOS Scanbody H4 <i>inkl. Standard-Schraube</i>	IOS Scanbody H7
	 IM DOPPELPACK	 IM DOPPELPACK	
ø 4,8 mm	EVO-PI-CO-MACH-4.8	INTRA-PI-CO-MACH-4.8-H4	–
Art-Nr.:	ZFX05002275	ZFX05002301	–

Schraubendreher

	Standard-Schraube	Sechsrund-Schraube 	Scanbodies
ø 4,8 mm	AORAKI	–	FUJI
 Bestellinformationen zu Schraubendrehern ab Seite 8			

PI-HE Type für das P-I External Hexagon® Implantatsystem

Scan-Bodies

	Desktop Scanbody <i>inkl. Standard-Schraube</i>	IOS Scanbody H4 <i>inkl. Standard-Schraube</i>	IOS Scanbody H7 <i>inkl. Standard-Schraube</i>
	 IM DOPPELPAK	 IM DOPPELPAK	 IM DOPPELPAK
ø 3,5 mm	EVO-PI-HE-MACH-3.5	INTRA-PI-HE-MACH-3.5-H4	INTRA-PI-HE-MACH-3.5-H7
Art-Nr.:	ZFX05002276	ZFX05002302	ZFX05002305
ø 4,1 mm	EVO-PI-HE-MACH-4.1	INTRA-PI-HE-MACH-4.1-H4	INTRA-PI-HE-MACH-4.1-H7
Art-Nr.:	ZFX05002277	ZFX05002303	ZFX05002306
ø 5,1 mm	EVO-PI-HE-MACH-5.1	INTRA-PI-HE-MACH-5.1-H4	INTRA-PI-HE-MACH-5.1-H7
Art-Nr.:	ZFX05002278	ZFX05002304	ZFX05002307

Komponenten-Zubehör für direkt-verschraubte Prothetik

	Pre-Abutment Blank	Standard-Schraube	Modellanalog
			 IM DOPPELPAK
ø 3,5 mm	–	–	MC-Analog-PI-HE-3.5
Art-Nr.:	–	–	ZFX15002339
ø 4,1 mm	–	–	MC-Analog-PI-HE-4.1
Art-Nr.:	–	–	ZFX15002340
ø 5,1 mm	–	–	MC-Analog-PI-HE-5.1
Art-Nr.:	–	–	ZFX15002341

Schraubendreher

	Standard-Schraube	Sechsrund-Schraube 	Scanbodies
ø 3,5 mm	AORAKI	–	FUJI
ø 4,1 mm	AORAKI	–	FUJI
ø 5,1 mm	AORAKI	–	FUJI

 Bestellinformationen zu Schraubendrehern ab Seite 8

*max. möglicher Schraubenkanal-Winkel

PI-MT Type für das P-I Morse Taper® Implantatsystem

Scan-Bodies

	Desktop Scanbody <i>inkl. Standard-Schraube</i>	IOS Scanbody H4 <i>inkl. Standard-Schraube</i>	IOS Scanbody H7 <i>inkl. Standard-Schraube</i>
	 IM DOPPELPACK	 IM DOPPELPACK	 IM DOPPELPACK
ø3,5/5,1mm	EVO-PI-MT-MACH-3.5-5.1	INTRA-PI-MT-MACH-3.5-5.1-H4	INTRA-PI-MT-MACH-3.5-5.1-H7
Art-Nr.:	ZFX05002279	ZFX05002308	ZFX05002309

Komponenten-Zubehör

	Pre-Abutment Blank	Ersatzschraube	Modellanalog
			 IM DOPPELPACK
ø3,5/5,1mm	–	–	MC-Analog-PI-MT-3.5-5.1
Art-Nr.:	–	–	ZFX15002342

Schraubendreher

	Standard-Schraube	Sechsrund-Schraube 	Scanbodies
ø3,5/5,1mm	AORAKI	–	FUJI

 Bestellinformationen zu Schraubendrehern ab Seite 8

SE-ML Type für das Serf Multi DIE® Implantatsystem

Scan-Bodies

		Desktop Scanbody <i>inkl. Standard-Schraube</i>	IOS Scanbody H4	IOS Scanbody H7
				
		IM DOPPELPAK		
ø 3,3 mm	EVO-SE-ML-MACH-3.3	–	–	
Art-Nr.:	ZFX05002107	–	–	
ø 4,0 mm	EVO-SE-ML-MACH-4.0	–	–	
Art-Nr.:	ZFX05002108	–	–	
ø 5,0 mm	EVO-SE-ML-MACH-5.0	–	–	
Art-Nr.:	ZFX05002109	–	–	

Schraubendreher

		Standard-Schraube	Sechsrund-Schraube 	Scanbodies
ø 3,3 mm	AORAKI	–	FUJI	
ø 4,0 mm	AORAKI	–	FUJI	
ø 5,0 mm	AORAKI	–	FUJI	

 Bestellinformationen zu Schraubendrehern ab Seite 8

SE-MU Type für das Serf MUA TR WD® Abutmentsystem

Scan-Bodies

	Desktop Scanbody <i>inkl. Standard-Schraube</i>	IOS Scanbody H4	IOS Scanbody H7
	 <small>IM DOPPELPAK</small>		
ø 5,2mm	EVO-SE-MU-MACH-5.2	–	–
Art-Nr.:	ZFX05002105	–	–
ø 6,0mm	EVO-SE-MU-MACH-6.0	–	–
Art-Nr.:	ZFX05002106	–	–



Schraubendreher

	Standard-Schraube	Sechsrund-Schraube 	Scanbodies
ø 5,2mm	AORAKI	–	FUJI
ø 6,0mm	AORAKI	–	FUJI

 Bestellinformationen zu Schraubendrehern ab Seite 8





ST-BO Type für das Straumann Institut Bone Level® Implantatsystem

Scan-Bodies

		Desktop Scanbody <i>inkl. Standard-Schraube</i>	IOS Scanbody H4 <i>inkl. Standard-Schraube</i>	IOS Scanbody H7 <i>inkl. Standard-Schraube</i>
		 IM DOPPELPACK	 IM DOPPELPACK	 IM DOPPELPACK
ø 3,3 mm		EVO-ST-BO-MACH-3.3	INTRA-ST-BO-MACH-3.3-H4	INTRA-ST-BO-MACH-3.3-H7
Art-Nr.:		ZFX05002051	ZFX05002004	ZFX05002005
ø 4,1 / 4,8 mm		EVO-ST-BO-MACH-4.1-4.8	INTRA-ST-BO-MACH-4.1-4.8-H4	INTRA-ST-BO-MACH-4.1-4.8-H7
Art-Nr.:		ZFX05002052	ZFX05002006	ZFX05002007

Einzelkronen-Versorgung

Brücken-Versorgung

		Titanbasis rotationsgeschützt für Einzelkronen <i>Regular Design, inkl. Standard-Schraube Small Design, inkl. Standard-Schraube</i>		Titanbasis nicht rotationsgeschützt für Brücken <i>Regular Design, inkl. Standard-Schraube Small Design, inkl. Standard-Schraube</i>	
					
ø 3,3 mm		TI-Base-ST-BO-TBLO-3.3	S-TI-Base-ST-BO-TBLO-3.3	TI-Base-ST-BO-TBUL-3.3	S-TI-Base-ST-BO-TBUL-3.3
Art-Nr.:		ZFX11000733	ZFX11001148	ZFX11000735	ZFX11001150
ø 4,1 / 4,8 mm		TI-Base-ST-BO-TBLO-4.1-4.8	S-TI-Base-ST-BO-TBLO-4.1-4.8	TI-Base-ST-BO-TBUL-4.1-4.8	S-TI-Base-ST-BO-TBUL-4.1-4.8
Art-Nr.:		ZFX11000734	ZFX11001149	ZFX11000736	ZFX11001151

*max. möglicher Schraubenkanal-Winkel

Komponenten-Zubehör

Pre-Abutment Blank *inkl. Standard-Schraube*



Ersatzschraube *Standard-Schraube*



\vec{M}
Drehmoment

Modellanalog



IM DOPPELPAK

ø 3,3 mm	Pre-Abutment Blank	ST-BO-SCTI-3.3	35 Ncm	MC-Analog-ST-BO-3.3
Art-Nr.:	ZFX18000100	ZFX09000645		ZFX15002147
ø 4,1/4,8 mm	Pre-Abutment Blank	ST-BO-SCTI-4.1-4.8	35 Ncm	MC-Analog-ST-BO-4.1-4.8
Art-Nr.:	ZFX18000110	ZFX09000646		ZFX15002148

Komponenten-Zubehör für direkt-verschraubte Prothetik

Standard-Schraube

Sechsrund-Schraube

≤ 25°*



\vec{M}
Drehmoment



ø 3,3 mm	ST-BO-SCTI-3.3	35 Ncm	–
Art-Nr.:	ZFX09000645		–
ø 4,1/4,8 mm	ST-BO-SCTI-4.1-4.8	35 Ncm	–
Art-Nr.:	ZFX09000646		–

Schraubendreher

Standard-Schraube

Sechsrund-Schraube



Scanbodies

ø 3,3 mm	EIGER	–	FUJI
ø 4,1/4,8 mm	EIGER	–	FUJI

Bestellinformationen zu Schraubendrehern ab Seite 8

ST-MU Type für das Straumann Institut Multi-Base® Abutmentsystem

Scan-Bodies

Brücken-Versorgung

Desktop Scanbody *inkl. Standard-Schraube*

IOS Scanbody H4 *inkl. Standard-Schraube*

Titanbasis nicht rotationsgeschützt für Brücken *Small Design, inkl. Standard-Schraube*

IM DOPPELPAK

IM DOPPELPAK



ø 3,5 mm	EVO-ST-MU-MACH-3.5	INTRA-ST-MU-MACH-3.5-H4	S-TI-Base-ST-MU-TBUL-3.5
Art-Nr.:	ZFX05002168	ZFX05001934	ZFX11002096
ø 4,5 mm	EVO-ST-MU-MACH-4.5	INTRA-ST-MU-MACH-4.5-H4	S-TI-Base-ST-MU-TBUL-4.5
Art-Nr.:	ZFX05002169	ZFX05001935	ZFX11002097
ø 6,5 mm	EVO-ST-MU-MACH-6.5	INTRA-ST-MU-MACH-6.5-H4	S-TI-Base-ST-MU-TBUL-6.5
Art-Nr.:	ZFX05002170	ZFX05001936	ZFX11002098

Komponenten-Zubehör für direkt-verschraubte Prothetik

Pre-Abutment Blank

Standard-Schraube

Modellanalog

≤ 25°*



\vec{M}
Drehmoment



IM DOPPELPAK

ø 3,5 mm	–	ST-MU-SCTI-3.5-6.5	15 Ncm	MC-Analog-ST-MU-3.5
Art-Nr.:	–	ZFX09001011		ZFX15002302
ø 4,5 mm	–	ST-MU-SCTI-3.5-6.5	15 Ncm	MC-Analog-ST-MU-4.5
Art-Nr.:	–	ZFX09001011		ZFX15002303
ø 6,5 mm	–	ST-MU-SCTI-3.5-6.5	15 Ncm	MC-Analog-ST-MU-6.5
Art-Nr.:	–	ZFX09001011		ZFX15002304

Schraubendreher

Standard-Schraube

Sechsrund-Schraube



Scanbodies

ø 3,5 mm	EIGER	–	FUJI
ø 4,5 mm	EIGER	–	FUJI
ø 6,5 mm	EIGER	–	FUJI

Bestellinformationen zu Schraubendrehern ab Seite 8



*max. möglicher Schraubenkanal-Winkel

ST-NNC Type für das Straumann Institut Narrow Neck® Implantatsystem

Scan-Bodies

	Desktop Scanbody <i>inkl. Standard-Schraube</i>	IOS Scanbody H4	IOS Scanbody H7
	 <small>IM DOPPELPAK</small>		
ø 3,5 mm	EVO-ST-NNC-MACH-3.5	–	–
Art-Nr.:	ZFX05002184	–	–

Komponenten-Zubehör für direkt-verschraubte Prothetik

	Standard-Schraube		Sechsrund-Schraube
			
	≤ 25°*		
		\vec{M} Drehmoment	
ø 3,5 mm	ST-NNC-3.5	35 Ncm	–
Art-Nr.:	ZFX09-ST-NNC		–

Schraubendreher

	Standard-Schraube	Sechsrund-Schraube	Scanbodies
			
ø 3,5 mm	EIGER	–	FUJI



 Bestellinformationen zu Schraubendrehern ab Seite 8

ST-OC Type für das Straumann Institut Octa® (External Octagon) Implantatsystem

Scan-Bodies

		Desktop Scanbody <i>inkl. Standard-Schraube</i>	IOS Scanbody H4	IOS Scanbody H7
				
		<small>IM DOPPELPAK</small>		
ø 4,8 mm	EVO-ST-OC-MACH-4.8	–	–	
Art-Nr.:	ZFX05002280	–	–	
ø 6,5 mm	EVO-ST-OC-MACH-6.5	–	–	
Art-Nr.:	ZFX05002281	–	–	

Komponenten-Zubehör für direkt-verschraubte Prothetik

		Standard-Schraube	Sechsrund-Schraube
		$\leq 25^\circ$	
			
			\vec{M} Drehmoment
ø 4,8 mm	ST-OC-SCTI-4.8-6.5	15 Ncm	–
Art-Nr.:	ZFX09002326		–
ø 6,5 mm	ST-OC-SCTI-4.8-6.5	15 Ncm	–
Art-Nr.:	ZFX09002326		–

Schraubendreher



		Standard-Schraube	Sechsrund-Schraube	Scanbodies
ø 4,8 mm	EIGER	–		FUJI
ø 6,5 mm	EIGER	–		FUJI

 Bestellinformationen zu Schraubendrehern ab Seite 8



*max. möglicher Schraubenkanal-Winkel

ST-SC Type für das Straumann Institut Screw-retained® Abutmentsystem

Scan-Bodies

		Desktop Scanbody <i>inkl. Standard-Schraube</i>	IOS Scanbody H4 <i>inkl. Standard-Schraube</i>	IOS Scanbody H7
				
		<small>IM DOPPELPACK</small>	<small>IM DOPPELPACK</small>	
ø 3,3 mm		EVO-ST-SC-MACH-35	INTRA-ST-SC-MACH-35-H4	–
Art-Nr.:		ZFX05D-ST-SC-35	ZFX05I-ST-SC-35-H4	–
ø 4,1 / 4,8 mm		EVO-ST-SC-MACH-46	INTRA-ST-SC-MACH-46-H4	–
Art-Nr.:		ZFX05D-ST-SC-46	ZFX05I-ST-SC-46-H4	–

Komponenten-Zubehör für direkt-verschraubte Prothetik

		Standard-Schraube		Sechsrund-Schraube
				
		<small>≤ 25°*</small>		
			<small>\bar{M} Drehmoment</small>	
ø 3,3 mm		TI-Screw-ST-SC	15 Ncm	–
Art-Nr.:		ZFX09-ST-SC		–
ø 4,1 / 4,8 mm		TI-Screw-ST-SC	15 Ncm	–
Art-Nr.:		ZFX09-ST-SC		–



Schraubendreher

		Standard-Schraube	Sechsrund-Schraube	Scanbodies
ø 3,5 mm		EIGER	–	FUJI
ø 3,5 mm		EIGER	–	FUJI

 Bestellinformationen zu Schraubendrehern ab Seite 8





ST-SY Type für das Straumann Institut SynOcta® Implantatsystem

Scan-Bodies

		Desktop Scanbody <i>inkl. Standard-Schraube</i>	IOS Scanbody H4 <i>inkl. Standard-Schraube</i>	IOS Scanbody H7 <i>inkl. Standard-Schraube</i>
				
		IM DOPPELPAK	IM DOPPELPAK	IM DOPPELPAK
ø 3,5 mm	EVO-ST-SY-MACH-3.5	INTRA-ST-SY-MACH-3.5-H4	INTRA-ST-SY-MACH-3.5-H7	
Art-Nr.:	ZFX05002053	ZFX05002008	ZFX05002009	
ø 4,8 mm	EVO-ST-SY-MACH-4.8	INTRA-ST-SY-MACH-4.8-H4	INTRA-ST-SY-MACH-4.8-H7	
Art-Nr.:	ZFX05002054	ZFX05002010	ZFX05002011	
ø 6,5 mm	EVO-ST-SY-MACH-6.5	INTRA-ST-SY-MACH-6.5-H4	INTRA-ST-SY-MACH-6.5-H7	
Art-Nr.:	ZFX05002055	ZFX05002012	ZFX05002013	

Einzelkronen-Versorgung

Brücken-Versorgung

		Titanbasis rotationsgeschützt für Einzelkronen <i>Regular Design, inkl. Standard-Schraube Small Design, inkl. Standard-Schraube</i>		Titanbasis nicht rotationsgeschützt für Brücken <i>Regular Design, inkl. Standard-Schraube Small Design, inkl. Standard-Schraube</i>	
					
ø 3,5 mm	TI-Base-ST-SY-TBLO-3.5	S-TI-Base-ST-SY-TBLO-3.5	–	–	S-TI-Base-ST-SY-TBUL-3.5
Art-Nr.:	ZFX11000737	ZFX11001152	–	–	ZFX11000740
ø 4,8 mm	TI-Base-ST-SY-TBLO-4.8	–	–	TI-Base-ST-SY-TBUL-4.8	–
Art-Nr.:	ZFX11000738	–	–	ZFX11000741	–
ø 6,5 mm	TI-Base-ST-SY-TBLO-6.5	–	–	TI-Base-ST-SY-TBUL-6.5	–
Art-Nr.:	ZFX11000739	–	–	ZFX11000742	–

*max. möglicher Schraubenkanal-Winkel

Komponenten-Zubehör

Pre-Abutment Blank
inkl. Standard-Schraube**Ersatzschraube**
Standard-Schraube
 \vec{M}
Drehmoment
Modellanalog

IM DOPPELPAK

ø 3,5 mm	–	ST-SY-SCTI-3.5	35 Ncm	MC-Analog-ST-SY-3.5
Art-Nr.:	–	ZFX09000648		ZFX15002149
ø 4,8 mm	Pre-Abutment Blank	ST-SY-SCTI-4.8-6.5	35 Ncm	MC-Analog-ST-SY-4.8
Art-Nr.:	ZFX18000120	ZFX09000649		ZFX15002150
ø 6,5 mm	Pre-Abutment Blank	ST-SY-SCTI-4.8-6.5	35 Ncm	MC-Analog-ST-SY-6.5
Art-Nr.:	ZFX18000130	ZFX09000649		ZFX15002151

Komponenten-Zubehör für direkt-verschraubte Prothetik

Standard-Schraube**Sechsrund-Schraube**

≤ 25°*

 \vec{M}
Drehmoment

ø 3,5 mm	ST-SY-SCTI-3.5	35 Ncm	–	
Art-Nr.:	ZFX09000648		–	
ø 4,8 mm	ST-SY-SCTI-4.8-6.5	35 Ncm	–	
Art-Nr.:	ZFX09000649		–	
ø 6,5 mm	ST-SY-SCTI-4.8-6.5	35 Ncm	–	
Art-Nr.:	ZFX09000649		–	

Schraubendreher



Standard-Schraube**Sechsrund-Schraube****Scanbodies**

ø 3,5 mm	EIGER	–	FUJI
ø 4,8 mm	EIGER	–	FUJI
ø 6,5 mm	EIGER	–	FUJI



Bestellinformationen zu Schraubendrehern ab Seite 8

ST-SY-CE Type für das Straumann Institut SynOcta® Cementable Implantatsystem

Scan-Bodies

		Desktop Scanbody <i>inkl. Standard-Schraube</i>	IOS Scanbody H4 <i>inkl. Standard-Schraube</i>	IOS Scanbody H7 <i>inkl. Standard-Schraube</i>
		 IM DOPPELPAK	 IM DOPPELPAK	 IM DOPPELPAK
ø 4,8 mm		EVO-ST-SY-MACH-4.8	INTRA-ST-SY-MACH-4.8-H4	INTRA-ST-SY-MACH-4.8-H7
Art-Nr.:		ZFX05002054	ZFX05002010	ZFX05002011
ø 6,5 mm		EVO-ST-SY-MACH-6.5	INTRA-ST-SY-MACH-6.5-H4	INTRA-ST-SY-MACH-6.5-H7
Art-Nr.:		ZFX05002055	ZFX05002012	ZFX05002013

Komponenten-Zubehör für direkt-verschraubte Prothetik

		Pre-Abutment Blank	Standard-Schraube	Modellanalog
			 $\leq 25^\circ$	 IM DOPPELPAK
ø 4,8 mm		–	ST-SY-CE-SCTI-4.8-6.5	MC-Analog-ST-SY-4.8
Art-Nr.:		–	ZFX09002325	ZFX15002150
ø 6,5 mm		–	ST-SY-CE-SCTI-4.8-6.5	MC-Analog-ST-SY-6.5
Art-Nr.:		–	ZFX09002325	ZFX15002151

Schraubendreher

		Standard-Schraube	Sechsrund-Schraube 	Scanbodies
ø 4,8 mm		EIGER	–	FUJI
ø 6,5 mm		EIGER	–	FUJI



 Bestellinformationen zu Schraubendrehern ab Seite 8

*max. möglicher Schraubenkanal-Winkel



SW-GL Type für das Sweden & Martina Global® Implantatsystem

Scan-Bodies

	Desktop Scanbody <i>inkl. Standard-Schraube</i>	IOS Scanbody H4 <i>inkl. Standard-Schraube</i>	IOS Scanbody H7 <i>inkl. Standard-Schraube</i>
	 IM DOPPELPACK	 IM DOPPELPACK	 IM DOPPELPACK
ø 3,8 mm	EVO-SW-GL-MACH-3.8	INTRA-SW-GL-MACH-3.8-H4	INTRA-SW-GL-MACH-3.8-H7
Art-Nr.:	ZFX05002261	ZFX05001124	ZFX05001125
ø 4,3 mm	EVO-SW-GL-MACH-4.3	INTRA-SW-GL-MACH-4.3-H4	INTRA-SW-GL-MACH-4.3-H7
Art-Nr.:	ZFX05002262	ZFX05001126	ZFX05001127
ø 4,8 mm	EVO-SW-GL-MACH-4.8	INTRA-SW-GL-MACH-4.8-H4	INTRA-SW-GL-MACH-4.8-H7
Art-Nr.:	ZFX05002263	ZFX05001128	ZFX05001129
ø 5,5 mm	EVO-SW-GL-MACH-5.5	INTRA-SW-GL-MACH-5.5-H4	INTRA-SW-GL-MACH-5.5-H7
Art-Nr.:	ZFX05002264	ZFX05001130	ZFX05001131

Komponenten-Zubehör

	Pre-Abutment Blank	Ersatzschraube	Modellanalog
			 IM DOPPELPACK
ø 3,8 mm	–	–	MC-Analog-SW-GL-3.8
Art-Nr.:	–	–	ZFX15002315
ø 4,3 mm	–	–	MC-Analog-SW-GL-4.3
Art-Nr.:	–	–	ZFX15002316
ø 4,8 mm	–	–	MC-Analog-SW-GL-4.8
Art-Nr.:	–	–	ZFX15002317
ø 5,5 mm	–	–	MC-Analog-SW-GL-5.5
Art-Nr.:	–	–	ZFX15002318

Schraubendreher



	Standard-Schraube	Sechsrund-Schraube 	Scanbodies
ø 3,8 mm	FUJI	–	FUJI
ø 4,3 mm	FUJI	–	FUJI
ø 4,8 mm	FUJI	–	FUJI
ø 5,5 mm	FUJI	–	FUJI

 Bestellinformationen zu Schraubendrehern ab Seite 8

*max. möglicher Schraubenkanal-Winkel

SW-OU Type für das Sweden & Martina Outlink2® Implantatsystem

Scan-Bodies

	Desktop Scanbody <i>inkl. Standard-Schraube</i>	IOS Scanbody H4 <i>inkl. Standard-Schraube</i>	IOS Scanbody H7 <i>inkl. Standard-Schraube</i>
	 IM DOPPELPAK	 IM DOPPELPAK	 IM DOPPELPAK
ø 3,3 mm	EVO-SW-OU-MACH-3.3	INTRA-SW-OU-MACH-3.3-H4	INTRA-SW-OU-MACH-3.3-H7
Art-Nr.:	ZFX05002265	ZFX05001142	ZFX05001143
ø 4,1 mm	EVO-SW-OU-SP-MACH-4.1	INTRA-SW-OU-SP-MACH-4.1-H4	INTRA-SW-OU-SP-MACH-4.1-H7
Art-Nr.:	ZFX05002266	ZFX05001146	ZFX05001147
ø 3,75/4,1 mm	EVO-SW-OU-MACH-3.75-4.1	INTRA-SW-OU-MACH-3.75-4.1-H4	INTRA-SW-OU-MACH-3.75-4.1-H7
Art-Nr.:	ZFX05002267	ZFX05001144	ZFX05001145
ø 5,0 mm	EVO-SW-OU-MACH-5.0	INTRA-SW-OU-MACH-5.0-H4	INTRA-SW-OU-MACH-5.0-H7
Art-Nr.:	ZFX05002268	ZFX05001148	ZFX05001149

Komponenten-Zubehör

	Pre-Abutment Blank	Ersatzschraube	Modellanalog
			 IM DOPPELPAK
ø 3,3 mm	–	–	MC-Analog-SW-OU-3.3
Art-Nr.:	–	–	ZFX15002319
ø 4,1 mm	–	–	MC-Analog-SW-OU-SP-4.1
Art-Nr.:	–	–	ZFX15002320
ø 3,75/4,1 mm	–	–	MC-Analog-SW-OU-3.75-4.1
Art-Nr.:	–	–	ZFX15002321
ø 5,0 mm	–	–	MC-Analog-SW-OU-5.0
Art-Nr.:	–	–	ZFX15002322



Schraubendreher

	Standard-Schraube	Sechsrund-Schraube 	Scanbodies
ø 3,3 mm	FUJI	–	FUJI
ø 4,1 mm	FUJI	–	FUJI
ø 3,75/4,1 mm	FUJI	–	FUJI
ø 5,0 mm	FUJI	–	FUJI

 Bestellinformationen zu Schraubendrehern ab Seite 8

SW-PR Type für das Sweden & Martina Premium Kohno® Implantatsystem

Scan-Bodies

	Desktop Scanbody <i>inkl. Standard-Schraube</i>	IOS Scanbody H4 <i>inkl. Standard-Schraube</i>	IOS Scanbody H7 <i>inkl. Standard-Schraube</i>
	 IM DOPPELPAK	 IM DOPPELPAK	 IM DOPPELPAK
ø 3,3 mm	EVO-SW-PR-MACH-3.3	INTRA-SW-PR-MACH-3.3-H4	INTRA-SW-PR-MACH-3.3-H7
Art-Nr.:	ZFX05002251	ZFX05001114	ZFX05001115
ø 3,8 mm	EVO-SW-PR-MACH-3.8	INTRA-SW-PR-MACH-3.8-H4	INTRA-SW-PR-MACH-3.8-H7
Art-Nr.:	ZFX05002252	ZFX05001116	ZFX05001117
ø 4,25 mm	EVO-SW-PR-MACH-4.25	INTRA-SW-PR-MACH-4.25-H4	INTRA-SW-PR-MACH-4.25-H7
Art-Nr.:	ZFX05002253	ZFX05001118	ZFX05001119
ø 5,0 mm	EVO-SW-PR-MACH-5.0	INTRA-SW-PR-MACH-5.0-H4	INTRA-SW-PR-MACH-5.0-H7
Art-Nr.:	ZFX05002254	ZFX05001120	ZFX05001121
ø 6,0 mm	EVO-SW-PR-MACH-6.0	INTRA-SW-PR-MACH-6.0-H4	INTRA-SW-PR-MACH-6.0-H7
Art-Nr.:	ZFX05002255	ZFX05001122	ZFX05001123

Komponenten-Zubehör

	Pre-Abutment Blank	Ersatzschraube	Modellanalog
			 IM DOPPELPAK
ø 3,3 mm	–	–	MC-Analog-SW-PR-3.3
Art-Nr.:	–	–	ZFX15002310
ø 3,8 mm	–	–	MC-Analog-SW-PR-3.8
Art-Nr.:	–	–	ZFX15002311
ø 4,25 mm	–	–	MC-Analog-SW-PR-4.25
Art-Nr.:	–	–	ZFX15002312
ø 5,0 mm	–	–	MC-Analog-SW-PR-5.0
Art-Nr.:	–	–	ZFX15002313
ø 6,0 mm	–	–	MC-Analog-SW-PR-6.0
Art-Nr.:	–	–	ZFX15002314

*max. möglicher Schraubenkanal-Winkel



Schraubendreher

	<i>Standard-Schraube</i>	<i>Sechsrund-Schraube</i> 	<i>Scanbodies</i>
ø 3,3 mm	FUJI	–	FUJI
ø 3,8 mm	FUJI	–	FUJI
ø 4,25 mm	FUJI	–	FUJI
ø 5,0 mm	FUJI	–	FUJI
ø 6,0 mm	FUJI	–	FUJI

 Bestellinformationen zu Schraubendrehern ab Seite 8

TH-SP Type für das Thommen Medical SPI® Implantatsystem

Scan-Bodies

	Desktop Scanbody <i>inkl. Standard-Schraube</i>	IOS Scanbody H4 <i>inkl. Standard-Schraube</i>	IOS Scanbody H7 <i>inkl. Standard-Schraube</i>
	 IM DOPPELPAK	 IM DOPPELPAK	 IM DOPPELPAK
ø 3,5 mm	EVO-TH-SP-MACH-3.5	INTRA-TH-SP-MACH-3.5-H4	INTRA-TH-SP-MACH-3.5-H7
Art-Nr.:	ZFX05002246	ZFX05001104	ZFX05001105
ø 4,0 mm	EVO-TH-SP-MACH-4.0	INTRA-TH-SP-MACH-4.0-H4	INTRA-TH-SP-MACH-4.0-H7
Art-Nr.:	ZFX05002247	ZFX05001106	ZFX05001107
ø 4,5 mm	EVO-TH-SP-MACH-4.5	INTRA-TH-SP-MACH-4.5-H4	INTRA-TH-SP-MACH-4.5-H7
Art-Nr.:	ZFX05002248	ZFX05001108	ZFX05001109
ø 5,0 mm	EVO-TH-SP-MACH-5.0	INTRA-TH-SP-MACH-5.0-H4	INTRA-TH-SP-MACH-5.0-H7
Art-Nr.:	ZFX05002249	ZFX05001110	ZFX05001111
ø 6,0 mm	EVO-TH-SP-MACH-6.0	INTRA-TH-SP-MACH-6.0-H4	INTRA-TH-SP-MACH-6.0-H7
Art-Nr.:	ZFX05002250	ZFX05001112	ZFX05001113



Komponenten-Zubehör

	Pre-Abutment Blank	Ersatzschraube	Modellanalog
			 IM DOPPELPAK
ø 3,5 mm	–	–	MC-Analog-TH-SP-3.5
Art-Nr.:	–	–	ZFX15002284
ø 4,0 mm	–	–	MC-Analog-TH-SP-4.0
Art-Nr.:	–	–	ZFX15002285
ø 4,5 mm	–	–	MC-Analog-TH-SP-4.5
Art-Nr.:	–	–	ZFX15002286
ø 5,0 mm	–	–	MC-Analog-TH-SP-5.0
Art-Nr.:	–	–	ZFX15002287
ø 6,0 mm	–	–	MC-Analog-TH-SP-6.0
Art-Nr.:	–	–	ZFX15002288

* max. möglicher Schraubenkanal-Winkel

** direkt verschraubte Prothetik; keine Abwinkelung möglich

Komponenten-Zubehör für direkt-verschraubte Prothetik

Standard-Schraube*			Sechsrund-Schraube		
0°			≤ 25°		
					
		\vec{M} Drehmoment			\vec{M} Drehmoment
ø 3,5 mm	TH-SP-SCTI-3.5	15 Ncm	TI-Screw-TH-SP-3.5	15 Ncm	
Art-Nr.:	ZFX09002251		ZFX09-TH-SP-35		
ø 4,0 mm	TH-SP-SCTI-4.0-6.0	25 Ncm	TI-Screw-TH-SP-4.0-5.0	25 Ncm	
Art-Nr.:	ZFX09002250		ZFX09-TH-SP-4050		
ø 4,5 mm	TH-SP-SCTI-4.0-6.0	25 Ncm	TI-Screw-TH-SP-4.0-5.0	25 Ncm	
Art-Nr.:	ZFX09002250		ZFX09-TH-SP-4050		
ø 5,0 mm	TH-SP-SCTI-4.0-6.0	25 Ncm	TI-Screw-TH-SP-4.0-5.0	25 Ncm	
Art-Nr.:	ZFX09002250		ZFX09-TH-SP-4050		
ø 6,0 mm	TH-SP-SCTI-4.0-6.0	25 Ncm	–		
Art-Nr.:	ZFX09002250		–		

Schraubendreher

	Standard-Schraube**	Sechsrund-Schraube		Scanbodies
ø 3,5 mm	–	MERU		FUJI
ø 4,0 mm	–	MERU		FUJI
ø 4,5 mm	–	MERU		FUJI
ø 5,0 mm	–	MERU		FUJI
ø 6,0 mm	–	MERU		FUJI

 Bestellinformationen zu Schraubendrehern ab Seite 8



BESTELLEN SIE UNTER
order@zfx-dental.com

Zfx GmbH

Kopernikusstraße 15
85221 Dachau, Deutschland
Tel. +49 81 31 33 244 - 0
Fax +49 81 31 33 244 - 10
order@zfx-dental.com

A COMPANY OF
 **ZimVie**